

# VIRTUVE

KATALOGS 2023  
2024

30<sup>TH</sup>  
ANNIVERSARY

UNA STORIA DA RACCONTARE, UN'ESPERIENZA DA CONDIVIDERE.  
STĀSTS, KO IZSTĀSTĪT, PIEREDZE AR KO DALĪTIES



MADE IN ITALY

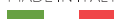

# FOKUSĒJIES DZĪVEI PADAROT TO VIEGLĀKU



# MŪSU CEĻŠ UZ ILGTSPĒJĪGU NĀKOTNI

## INOVĀCIJAS, ILGTSPĒJĪBA UN SKATIENS NĀKOTNĒ.

Jau gadiem ilgi Elleci ir mainījis savu uzmanību un attieksmi vides aizsardzības praksei, vienmēr meklējot jaunus risinājumus ilgtspējīgai biznesa attīstībai.

### 1\_ ELLECI CENTRS 1

Ražošanas vēsture, iekārtas, kas vērstas uz elastību un ražošanas pielāgošanu.

### 2\_ ELLECI CENTRS 2

Neatkarīga, ļoti ilgtspējīga un uz tehnoloģijām balstīta ražotne, kurā tradīcijas un zināšanas iet roku rokā ar mūsdienīgumu un automatizāciju.

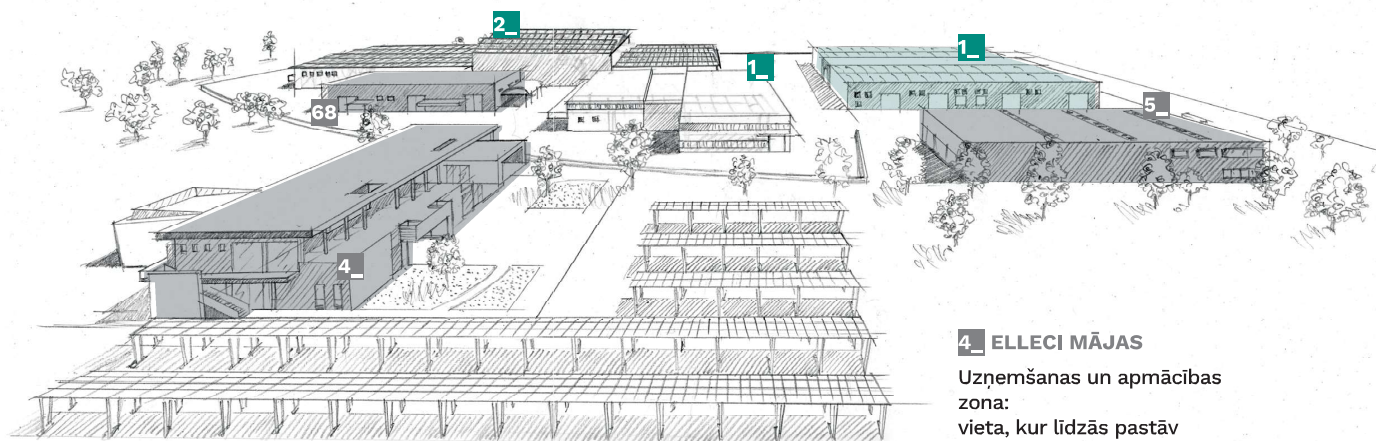

### 4\_ ELLECI MĀJAS

Uzņēmšanas un apmācības zona: vieta, kur līdzās pastāv pagātnes un nākotnes vīzijas. Pilnīga Elleci pasaules pieredze.

## 2 CENTRI AR DIFERENCĒTU RAŽOŠANU

**100,000 M<sup>2</sup>**  
AR DIFERENCĒTĀM RAŽOŠANAS  
TĒLPĀM  
50,000 M<sup>2</sup> SEGTA DARBĪBAS ZONA

**2.3 MW**  
IZMANTOTĀ ENERĢIJA NO  
ATJAUNOJAMIEM AVOTIEM  
~50% NO KOPEJĀĀ ENERĢIJAS PATĒRIŅĀ

### 3\_ INOVĀCIJU CENTRS

Iestāde, kas veltīta pētniecībai un attīstībai, kur veidojas visambiciozākās idejas.

### 5\_ ELLECI SERVISS

Vērtība un rūpes par attiecībām: šī telpa ir pilnībā vēsta uz uzticības un attiecību stiprināšanu ar klientiem pirms- un pēc pārdošanas fāzes.

# MANTOJUMS

## STĀSTS, KO IZSTĀSTĪT, PIEREDZE, AR KO DALĪTIES



Elleci raugās nākotnē ar jaunu skatienu.

Uzņēmuma kultūra, kas balstās uz tradīcijām, kas virza nākotnes ideju attīstību, laika gaitā ir ļāvusi sasniegt galvenos atskaites punktus, radot jauninājumus un rosinot jaunus veidus, kā izjust gatavošanas zonu virtuvē.

### ARHITEKTŪRAS EVOLŪCIJA RAŽOŠANAS IEKĀRTĀM

No 1992. gada līdz mūsdienām arhitektūra tika izstrādāta, tā lai izteiktu Elleci mainīgo seju no viena laikmeta uz nākamo.

### VEIKSMES STĀSTS

*starp mūsu nozīmīgākajiem arhīviem*

*ir "Izcilības stāsti"*

*kā daļa no*

**100 Eccellenze** pasākumi

*Itālijas uzņēmumiem, kuri*

*ar savu darbu ir devuši*

*ieguldījumu tautas vērtību*

*un atjautības gara*

*stiprināšanā.*



**MIDA TERRA DI FRANCIA**  
Pirmā izgatavotā izlietne



# 30 GADUS VIENMĒR VIENU SOLI PRIEKŠĀ



## TEHNOLOĢISKĀ VADĪBA

Izpēte, eksperimenti un pielietotās tehnoloģijas palīdz produktam no radīšanas procesa sākuma posma līdz pat beigām.

Gadī iet, bet aizraušanās ar jauninājumiem paliek. 30 gadus vēlme pilnveidoties ir nemainīga, ar idejām, kas tiek pastāvīgi atjauninātas un produktiem, kas vienmēr ir mūsdienīgi.

No pirmsākuma un nākotnē Elleci komanda vienmēr ir apņēmusies meklēt labākos ergonomiskos risinājumus. Uzņēmuma uzmanības centrā ir garšas evolūcijas virzīšana virtuvē ar radošuma un tehnoloģiskā progresa palīdzību, kas arvien meklē jaunas emocijas.



**SPAZIO 900**  
Red Dot Product Design 2023  
IF Design Award 2023

# KOMPETENCE

## PAREDZĒT NĀKOTNI IR MŪSU PANĀKUMU PAMATS.



Elleci pētniecības un attīstības komanda sastāv no profesionāļiem, kuri ir apņēmušies formulēt novatoriskus risinājumus, ar korporatīvo vīziju, kuras pamatā ir attīstīt know-how sasniedzot izcilību. Jauni, īpaši izturīgi materiāli, kas ražoti izmantojot inteligentu dizainu un ļoti efektīvus ražošanas procesus.

Inovācijas ietver GPS (Granitek ražošanas sistēma), kas vienmērīgi izplata visas sastāvdaļas, kas integrētas masā, dot virsmai unikālu izskatu, izturību un lielāku pretestību pret termisko šoku, skāpējumiem un triecieniem.

### SĀKUMĀ INOVĀCIJA

Kaislība, centība un uzmanība detaļām katrā ražošanas procesa posmā.

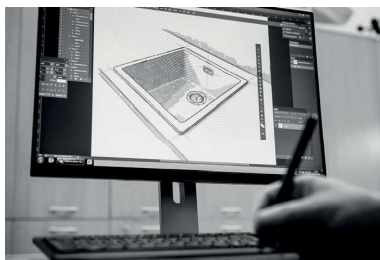



**SERTIFIKĀTI**  
100% SERTIFICĒTA KVALITĀTE



**ISO 9001/2015**  
KVALITĀTES VADĪBAI, lai nodrošinātu klientu apmierinātību, nepārtrauktas attīstības un uzņēmuma darbības uzlabošanas ziņā.



**ISO 14001/2015**  
VIDES PĀRVALDĪBAI, ņemot vērā uzņēmuma darbības pareizu ietekmi uz ekosistēmu.



**ISO 45001/2018**  
Darba drošības un veselības pārvaldībai.



Ievērojot sertifikācijas iestādes noteiktos standartus un procedūras, Elleci izlietņu ražošanā izmantotais materiāls ir ļoti higiēnisks un piemērots saskarei ar pārtiku.



Elleci kompozitmateriālu izlietnes atbilst visstingrākajiem noteikumiem attiecībā uz gaistošo organisko savienojumu emisijas līmeni.

Izlietne\_Ego 500 G68 Bianco  
Maisītājs\_Volta G68 Bianco

# MATERIĀLI

**KERATEK**<sup>®</sup>  
CERAMIC NANOTECHNOLOGY CN6

## NOVĒRTĒ

Spilgtas, dziļas un intensīvas krāsas, kas uzreiz piesaista uzmanību.

Īpaši gluda un pārsteidzoši kompakta virsma rada zīdainu efektu jau ar pirmo kontaktu. Keratek, novatorisks materiāls, kas radīts, lai pārsteigtu; unikālais materiāla sastāvs garantē skaistumu.

Veiktspējas izteiksmē izturība un augsta izturība pret termisko triecienu un triecieniem.

KERATEK ir NSV sertificēta un ir piemērota saskarei ar pārtiku. Pievilcīgs, higiēnisks un viegli tīrāms. Tas ir materiāls, kam ir nozīme, katrā mikrodaļiņā.

★

20 ANNI - YEARS  
WARRANTY  
GARANTITO



★

Izlietnēm ir 24 mēnešu likumā noteiktā garantija.

### ZĪDA EFEKTA VIRSMA

GLUDA, BLĪVA UN ZĪDAINA KATRĀ PIESKĀRIENĀ,  
TĀ IR IDEĀLA FUNKCIONALITĀTES UN ESTĒTIKAS  
SAVIENĪBA.





ĪPAŠĪBAS



ZĪDAINI  
GLUDA  
ĀPDARE



VIEGLI  
KOPJAMA  
VIRSMA



NETĪRĪMUS  
ĀTERŪDĒŠS  
EFEKTS



INTENSĪVA  
KRĀSA

UZLABOJUMI \*



AUGSTA  
SKRĀPEJUMU  
IZTURĪBA



TERMO ŠOKA  
IZTURĪBA

**K96 White**  
Balts

**K97 Light Grey**  
Gaiši pelēks

**K93 Dove Grey**  
Pelēks

**K99 Dark Grey**  
Tumši pelēks

**K95 Champagne**  
Šampanietis

**K86 Black**  
Melns

# MATERIĀLI

**GRANITEK**<sup>®</sup>

NATURAL GRANITE EFFECT

## INŽENĒRIJAS KVARCS

Radīts no vēlmes, lai virtuvē izmantotu kvarca tehnoloģijas raksturu, šī ir viela, kas izskatās svarīga. Saskaroties ar īpašo tekstūru, tā ir izturīga pret temperatūras izmaiņām un triecieniem, tā tika izgatavota lai kalpotu.

Pateicoties plašajam krāsu klāstam, kas pieejams trīs dažādos apdares veidos, ikviena detaļa tiks pamanīta.

**Metālisks:**  
Stilīgākais no visiem. Daudzās metāla daļiņas padara virsmu spīdīgu, spilgtu un dzirkstošu.

**Matēts:**  
Eleganti un diskrēti. Izsmalcināta apdare, ideāli piemērots vismodernākajiem kontekstiem.

**Klasisks:**  
Stilīga apdare, kas nekad neiziet no modes. Dabiskā akmens efekts, ko pastiprina hromatiskas faktūras, ideāls katrā detaļā.

★  
10 ANNI-YEARS WARRANTY  
GARANTITO



**DABĪGĀ KVARCA** VIRSMAS

TEKSTURĒTĀ VIRSMA IZSTRĀDĀTA TĀ,  
LAI PARĀDĪTU LABĀKĀS  
KVARCA ĪPAŠĪBAS.



★  
Izlietnēm ir 24 mēnešu likumā noteiktā garantija.

ĪPAŠĪBAS



DABISKA  
KVARCA  
VIRSMĀ



TRIECIENU  
IZTURĪGS



TERMĀLO  
ŠOKU  
IZTURĪGS



UZLABOTS  
MATERĪĀLS

UZLABOJUMI



JAUNA  
MELNA  
KRĀSA

METĀLISKS

M79 Aluminium  
Gaiši pelēks

M73 Titanium  
Tumši pelēks

M70 Nero metal  
Melns ar metālisku spīdumu

MATĒTS

G68 Bianco  
Balts

G48 Cemento  
Cementa pelēks

G43 Tortora  
Gaiši brūns

G78 Espresso  
Brūns

G40 Nero  
Melns

KLASISKS

G62 Bianco Antico  
Antīkji balts

G51 Avena  
Bēšīgs

G59 Antracite  
Antracīts

# FLOW-PRO ATVER VAĻĀ

Izcilība slēpjas vissīkākajās detaļās. Koncentrējoties uz funkcionalitāti un izstrādājuma dizainu, noteces sistēma maina izskatu atbilstoši jūsu stilam. Eleganti veidotā notece nodrošina estētisku nepārtrauktību izlietnē, savukārt centrālās vadības ierīces ergonomiskais dizains atvieglo tā lietošanu.



## OPEN UP

PIEEJAMA AUTOMĀTISKĀ VADĪBA,  
PĒC PIEPRASĪJUMA KOMPLEKTA  
VERSIJAI.



## FLOW PRO

Noteces koncepcijas maiņa  
pret modernu, praktisku  
drenāžas sistēmu, kuru  
ir viegli lietot un uzturēt.

# IZVĒLIES SAVUS PIEDERUMUS 3 LĪMENI VAI RĀK IESPĒJU.



Lai vēl vairāk pielāgotu izlietnes funkcionalitāti un pievienotu darbstacijai pievienoto vērtību, ir pieejams plašs piederumu klāsts, kas sniedz jums vēl patīkamāku pieredzi gatavošanās procesā.

PIRMAIS  
LĪMENIS



OTRAIS  
LĪMENIS

TREŠAIS  
LĪMENIS

Piederumus var sadalīt pa trim dažādām atbalsta virsmām, optimizējot katru izlietnes bļodas līmeni kombinētai lietošanai.

## PERSONALIZĒ TO

### DIZAINS, HIGIĒNA UN IZTURĪBA.

Elleci griešanas dēlis no HPL (augstspiediena lamināta) ir īpašs virtuves izlietnes papildinājums. Īpaši izturīgs un izturīgs pret skrāpējumiem, triecieniem un skrāpējumiem, tam ir neporaīna virsma, kas atvieglo tīrīšanu, tādējādi garantējot maksimālu higiēnu virtuvē. Tas ir pieejams Melnā, Pelēkā, Ozola, Gobas krāsā un koka.



# LIETO KATRU DIENU

**No pamošanās brīža līdz vēlam vakaram  
darbstacija ir ideāls sabiedrotais jebkurā  
diennakts laikā.**

Gadiem ilgi veiktiem pētījumiem virtuves un dzīvojamās telpas izmantošanai, tagad ir gatavošanas zona, kas pārsteigs ar katru jaunu kustību. Darbstacijā integrētie piederumi optimizē katru kustību un haosu uz virtuves darba virsmas.

Brokastis, vēlās brokastis, uzkodas, kokteiļi un vakariņas:  
viss tiek gatavots raiti un bez jebkāda stresa.



#### SKALOJAMĀIS TRAUKS

Ideāls piederums organizēšanai un notecināšanai.





**VIRTUVES MAISĪTĀJS WAVE Hromēts**

Maisītājs ar izcili estētiku un funkcionalitāti. Ar elegantu divu toņu dizainu, Wave ir augsts, ergonomisks grozāms snipis ar matētu melnu silikona izvelkamo smidzinātāju, kas var viegli sasniegt visus blōdas stūrus.



**GRIEŠANAS DĒĻIS ELEMENT Melns**

Daudzfunkcionāls griešanas dēlis ar praktiskām rievām integrētai lietošanai pie izlietnes vai uz virtuves darba virsmas.



# LIETO KATRU DIENU

## BROKASTIS



**Rokas mīklā, sakultas olas un krietna deva  
salduma- tas viss veido garšīgu recepti.**

Jauno modeli **Spazio 900** raksturo tīras līnijas  
dziļa un plaša XL mazgātne, kur var ievietot  
lielākus katlus un cepešpannas.

Izlietne Spazio 900 K96 Bianco  
Maisītājs Arcadia hromēta apdare



**Lauku mājas dizains, kas veidots mūsdienīgā stilā,**

ir piemērots gan modernai, gan klasiskai videi un, Pateicoties lielajai bļodas ietilpībai un daudzfunkcionālajiem griešanas dēļiem, sagatavošanas zona tiek pārveidota par pilnvērtīgu darba staciju.



# LIETO KATRU DIENU

## PUSDIENAS



Izlietne Life 480 G78 Espresso  
Maisītājs Trail G78 Espresso





**Diennakts laiks, kas veltīts vienkārši priekam redzēt ģimeni un dalīties ar dienas jaunumiem.**

**LIFE 480** ir ideāls sabiedrotais, jaunā Elleci ģimenes daļa ar savu drosmīgo, būtisko un moderno dizainu. Ar savām diskrētajām formām un līnijām, lielu žāvājamo daļu un piederumu komplektu, piemēram, daudzfunkcionāliem griešanas dēļiem, LIFE ir lieliski piemērots ikdienas lietošanai nodrošinot visu, ko Jūsu ģimene var vēlēties.

# LIETO KATRU DIENU

## VAKARIŅAS



Dāsns, elegants un jautrs brīdis, lai atskatītos uz dienu ar gardu ēdienu, iespējams, pat kaut ko priekš gardēžiem!

Kā īsta profesionāla darba vieta, **BEST 105** būtiskā darbstacija ir ideāla pat tad, ja Jūsu gatavošana ir ļoti sarežģīta.

Izlietne Best 105 K86 Black  
Maisītājs Hype Black Matt







## VIRTUVES IZLIETŅU PĀRSKATS



**SPAZIO 900**  
28.lpp



**SPAZIO 900 EXTRA**  
28.lpp

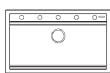

**BEST 360**  
34.lpp

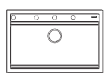

**BEST 130**  
34.lpp

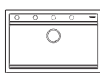

**BEST 130-F**  
34-41.lpp



**BEST/BEST-F 105**  
34-41.lpp



**BEST/BEST-F 104**  
34-41.lpp

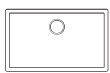

**ZEN/ZEN-F 130**  
42-49.lpp



**ZEN/ZEN-F 105**  
42-49.lpp



**ZEN/ZEN-F 102**  
42-49.lpp

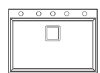

**KARISMA 120**  
IEGRIEŽAMA  
52.lpp



**KARISMA 105**  
IEGRIEŽAMA  
52.lpp

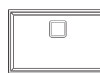

**KARISMA 120**  
PABŪVĒJAMA  
53.lpp



**KARISMA 105**  
PABŪVĒJAMA  
53.lpp

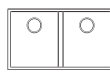

**INTEGRA 350**  
56.lpp

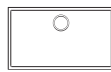

**INTEGRA 130**  
56.lpp



**INTEGRA 105**  
57.lpp



**INTEGRA 102**  
57.lpp

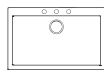

**QUADRA 130**  
IEGRIEŽAMA  
60.lpp



**QUADRA 110**  
IEGRIEŽAMA  
60.lpp



**QUADRA 105**  
IEGRIEŽAMA  
61.lpp



**QUADRA 102**  
IEGRIEŽAMA  
61.lpp



**QUADRA 100**  
IEGRIEŽAMA  
62.lpp



**QUADRA 50**  
IEGRIEŽAMA  
62.lpp

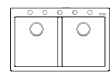

**QUADRA 350**  
IEGRIEŽAMA  
63.lpp

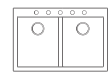

**QUADRA 340**  
IEGRIEŽAMA  
63.lpp

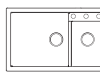

**QUADRA 440**  
IEGRIEŽAMA  
64.lpp



**QUADRA 150**  
IEGRIEŽAMA  
64.lpp

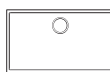

**QUADRA 130**  
PABŪVĒJAMA  
68.lpp



**QUADRA 110**  
PABŪVĒJAMA  
68.lpp



**QUADRA 105**  
PABŪVĒJAMA  
69.lpp



**QUADRA 102**  
PABŪVĒJAMA  
69.lpp



**QUADRA 100**  
PABŪVĒJAMA  
70.lpp



**QUADRA 50**  
PABŪVĒJAMA  
70.lpp

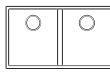

**QUADRA 350**  
PABŪVĒJAMA  
71.lpp

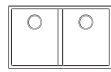

**QUADRA 340**  
PABŪVĒJAMA  
71.lpp

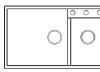

**QUADRA 440**  
PABŪVĒJAMA  
72.lpp



**QUADRA 150**  
PABŪVĒJAMA  
72.lpp

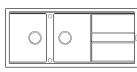

**BEST 500**  
76.lpp

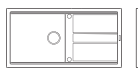

**BEST 480**  
76.lpp

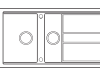

**BEST 475**  
77.lpp



**BEST 400**  
77.lpp



**BEST 450**  
78.lpp



**BEST 450**  
PABŪVĒJAMA  
78.lpp

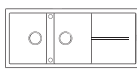

**UNICO 500**  
82.lpp

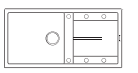

**UNICO 480**  
82.lpp

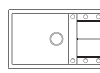

**UNICO 410**  
83.lpp



**UNICO 310**  
83.lpp



**UNICO 300**  
84.lpp



**UNICO 125**  
84.lpp



**UNICO CORNER**  
85.lpp



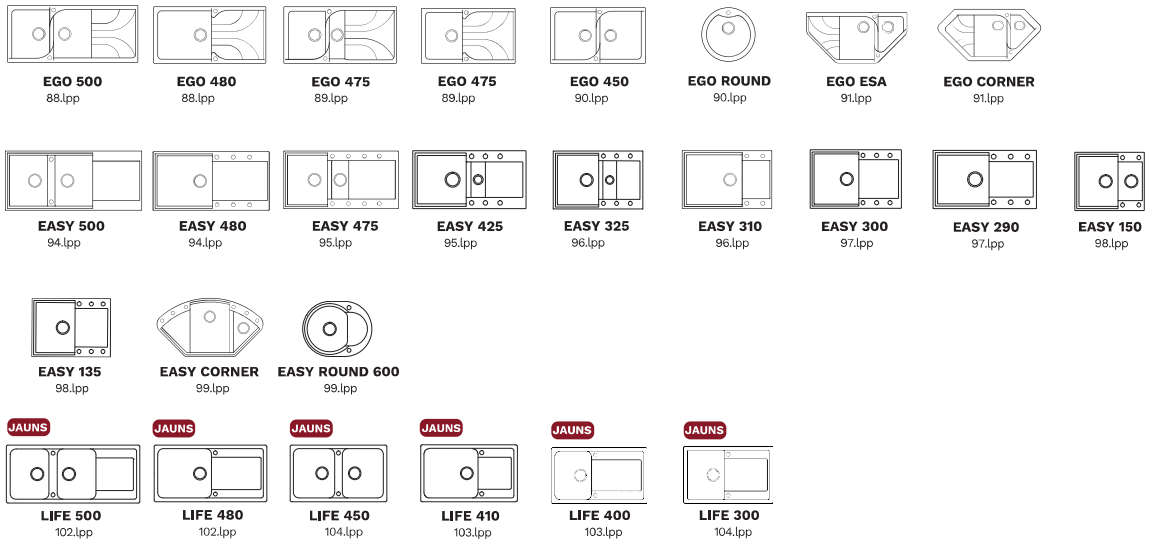

## PIEDERUMU PĀRSKATS

### PIEDERUMI ELEMENT

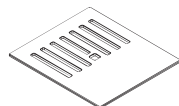

**GRIEŽAMĀIS DĒĻIS ELEMENT**  
no 108.lpp

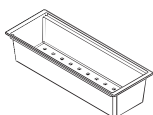

**CAURDURIS ELEMENT**  
110.-111.lpp

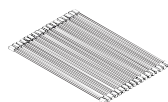

**LOKANĀIS PAKLĀJS ELEMENT**  
110.lpp

### PAPILDUS PIEDERUMI



**DEKORĀTĪVAIS  
NOSEGS**  
112.lpp



**FLOW-PRO AR  
PĀRPLŪDI**  
112.lpp



**POP-UP AR  
FLOW-PRO**  
112.lpp



**ZĪEPJU DOZATORS**  
111.lpp



**SPIEDPOGA**  
113.lpp



**NOPLŪDE AR  
PĀRPLŪDI**  
114.lpp



**VADĪBAS POGA  
AR NOPLŪDI**  
114.lpp

### DAŽĀDI PIEDERUMI

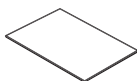

**GRIEŽAMĀIS DĒĻIS**  
116.lpp



**CAURDURIS**  
116.lpp

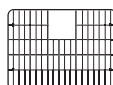

**PAMATNES**  
116.lpp



**GROZI**  
117.lpp



**CAURDURIS**  
117.lpp

ŪDENS MAISĪTĀJU PĀRSKATS

PROFESIONĀLIE

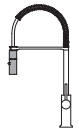

**ARCADIA**  
120.lpp

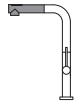

**FLUX**  
121.lpp

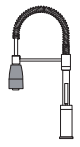

**CHEF**  
126.lpp

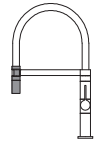

**WAVE**  
120.lpp

L FORMAS SNĪPIS



**KENT**  
121.lpp



**TEMA**  
126.lpp



**ARES**  
123.lpp



**STREAM PLUS**  
123.lpp



**STREAM**  
124.lpp



**IXORA**  
132.lpp



**TRAIL PLUS**  
125.lpp



**TRAIL**  
125.lpp



**SHELL PLUS**  
131.lpp



**SHELL**  
132.lpp



**ALUNA PLUS**  
133.lpp

KOMBINĒTS AR  
FILTRA PIESLĒGUMU



**TOURMALINE**  
122.lpp

APAĻAS FORMAS SNĪPIS

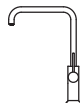

**HYPE**  
123.lpp



**ATHENA PLUS**  
127.lpp



**DORA PLUS**  
128.lpp

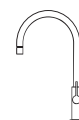

**VOLTA**  
130.lpp



**CADDY**  
131.lpp

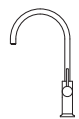

**CLUB**  
129.lpp



**ADIGE**  
128.lpp



**ATHENA**  
127.lpp



**BRIDGE**  
129.lpp



**CLOUD**  
130.lpp



**PO**  
135.lpp

TRADICIONĀLIE



**RIO**  
137.lpp



**RENO**  
134.lpp



**DRIVE**  
133.lpp



**SAVA**  
134.lpp



**SENN**  
135.lpp



**VENERE**  
136.lpp



**MINERVA**  
136.lpp

KOLEKCIJA  
**SPAZIO**



PAPILDUS  
INFORMĀCIJA  
SPAZIO



**MODERNĀ LAUKU MĀJA**

Spazio kolekcijas ģeometriskās līnijas ļauj saprātīgi un ārkārtīgi racionāli pilnībā izmantot bļodas tilpumu. Iekšējā mala, kas ļauj piederumiem slidēt, nodrošina ārkārtīgi ērtu lietošanu sagatavošanas un tīrīšanas darbību laikā.

 **red dot winner 2023**



PLUS **SPAZIO**



ELEMENT  
PIEDERUMI



FLOW-PRO



XL BĻODA

**KERATEK**  
CERAMIC NANOTECHNOLOGY CN6

-  **Black**  
K86
-  **Dove Grey**  
K93
-  **Champagne**  
K95
-  **White**  
K96
-  **Light Grey**  
K97
-  **Dark Grey**  
K99

## MODELIS SPAZIO

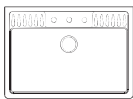

SPAZIO 900

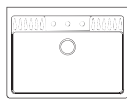

SPAZIO 900 EXTRA

**Komplektā:** Vietu taupošs sifons, integrēta Flow-Pro noplūde, taisnstūra pārplūde un montāžas āķi.

## IETEICAMIE PIEDERUMI

193

### SPAZIO GRIEŽAMĀIS DĒĻIS ELEMENT

ATH123WD  
108. Lpp.



#### Apdare



Melns Koka

## PERFEKTI SADERĪGS VIRTUVES MAISĪTĀJS



### ARCADIA - Black BK MOKARCBK

120. lpp.

Pieejamās krāsas



## PAPILDUS

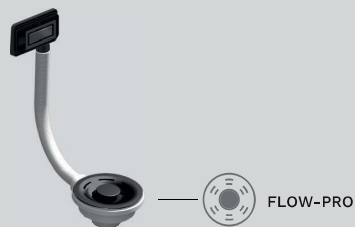

### ELEMENT KOMPLEKTS MELNS FLOW-PRO + PĀRPLŪDE Art. KITWPT-F-TVSSL-BK

142. Lpp

## elleci | BEAUTY



Produktu līnija, kas īpaši izstrādāta kompozitmateriālu izlietņu kopšanai.

Vairāk informācija **140.** lpp.

# SPAZIO 900

JAUNS



White  
K96

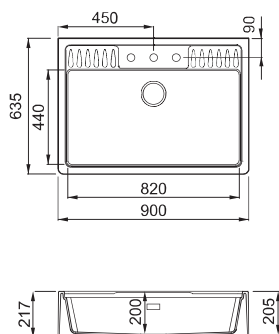

## PAPILDUS AKSESUĀRS



112. Lpp.

## MATERIĀLS UN KRĀSAS

| KERATEK        |          | Cena € |
|----------------|----------|--------|
| Black K86      | LKS90086 | 647,-  |
| Dove Grey K93  | LKS90093 | 647,-  |
| Champagne K95  | LKS90095 | 647,-  |
| White K96      | LKS90096 | 647,-  |
| Light Grey K97 | LKS90097 | 647,-  |
| Dark Grey K99  | LKS90099 | 647,-  |

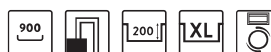

Izmēri (mm) **900 x 635**  
 Skapiša platums (mm) **900**  
 Izgriezums (mm) **Pēc šablona**  
 Bļodas dziļums (mm) **200**  
 Montāžas veids (mm) **Ar fasādi priekšā**

## IETEICAMIE PIEDERUMI

193

\* Šablons iekļauts komplektā vai arī pieejams lejupielādei no vietnes [www.elleci.com/it](http://www.elleci.com/it) īpašās lejupielādes sadaļas

# SPAZIO 900 EXTRA

JAUNS



White  
K96

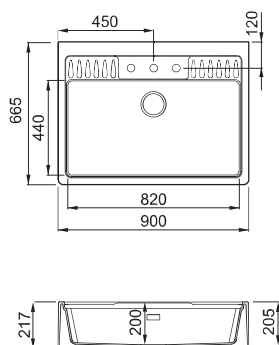

## PAPILDUS AKSESUĀRS



112. Lpp.

## MATERIĀLS UN KRĀSAS

| KERATEK        |             | Cena € |
|----------------|-------------|--------|
| Black K86      | LKS90086XLP | 647,-  |
| Dove Grey K93  | LKS90093XLP | 647,-  |
| Champagne K95  | LKS90095XLP | 647,-  |
| White K96      | LKS90096XLP | 647,-  |
| Light Grey K97 | LKS90097XLP | 647,-  |
| Dark Grey K99  | LKS90099XLP | 647,-  |



Izmēri (mm) **900 x 665**  
 Skapiša platums (mm) **900**  
 Izgriezums (mm) **Pēc šablona**  
 Bļodas dziļums (mm) **200**  
 Montāžas veids (mm) **Ar fasādi priekšā**

## IETEICAMIE PIEDERUMI

193

\* Šablons iekļauts komplektā vai arī pieejams lejupielādei no vietnes [www.elleci.com/it](http://www.elleci.com/it) īpašās lejupielādes sadaļas



# KOLEKCIJA BEST



PAPILDUS  
INFORMĀCIJA  
BEST



## VISPILNĪGĀKĀ DARBA STACIJA

Labi sakārtota virtuve ir lielisks sākumpunkts jebkurai receptei: Best darbstacijai ir XL bļoda un virkne piederumu, kas īpaši izstrādāti, lai viss būtu pa rokas. Polipropilēna caururis, elastīgais silikona paklājiņš, HPL griešanas dēlis un spiedpoga padara visu vienkāršāku un sasniedzamāku.

## BEST PLUS DARBSTACIJA



ELEMENT  
PIEDERUMS



FLOW-PRO



3 LĪMEŅI

**GRANITEK**  
NATURAL GRANITE EFFECT

● Titanium  
M73

● Aluminium  
M79

● Nero  
G40

● Tortora  
G43

● Cemento  
G48

● Bianco  
G68

● Espresso  
G78

● Avena  
G51

● Antracite  
G59

● Bianco Antico  
G62

**KERATEK**  
CERAMIC NANOTECHNOLOGY CN6

● Black  
K86

● Dove Grey  
K93

● Champagne  
K95

● White  
K96

● Light Grey  
K97

● Dark Grey  
K99



## MODELIS BEST

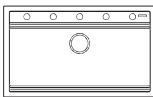

BEST 360

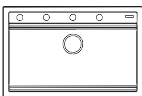

BEST 130

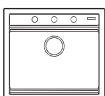

BEST 105



BEST 104

**Komplektā:** Vietu taupošs sifons, integrēts Flow-Pro noplūde, taisnstūrveida pārplūde un montāžas āķi.

## IETEICAMIE PIEDERUMU

93

### BEST GRIEŽAMĀIS DĒLIS ELEMENT

ATH073QU  
109. Lpp.



#### Apdare

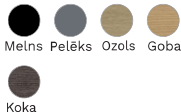

156

### LOKANĀIS PAKLĀJS FLEX 500 ELEMENT

ARS023BK  
110. Lpp.



#### Apdare



153

### BEST CAURDURIS

AVP034BK  
110. Lpp.



#### Apdare



97

### SPIEDPOGA ELEMENT

ASP13002BK  
113. Lpp.



#### Apdare



\*Lai iegūtu plašāku informāciju, skatiet piederumu sadaļu 106. lappusē

## PERFEKTI SADERĪGS VIRTUVES MAISĪTĀJS



### WAVE – Black BK MOKWAVBK

120. Lpp.

Pieejamās krāsas



## PAPILDUS

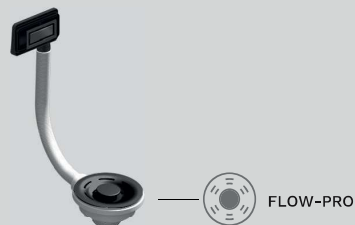

### ELEMENT KOMPLEKTS MELNS FLOW-PRO + PĀRPLŪDE Art.KITWPT-F-1VSL-L-BK

142. Lpp.

## elleci | BEAUTY



Produktu līnija, kas īpaši izstrādāta kompozitmateriālu izlietņu kopšanai.

Vairāk informācijas 140. lpp.

## BEST 360



WHITE  
K96

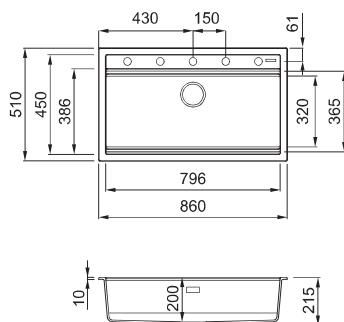

### PAPILDUS



112. Lpp.



Izmērs (mm) **860 x 510**  
 Skapiša platums (mm) **900**  
 Izgriezums (mm) **840 x 480**  
 Bļodas dziļums (mm) **200**  
 Montāžas veids **legriezama**

### IETEICAMIE PIEDERUMI

|     |    |    |    |     |     |     |
|-----|----|----|----|-----|-----|-----|
| 93  | 97 | 25 | 50 | 153 | 156 | 163 |
| 164 | 5  | 75 | 71 | 9   |     |     |

### MATERIĀLS UN KRĀSAS

| KERATEK        |          | Cena € |
|----------------|----------|--------|
| Black K86      | LKB36086 | 391,-  |
| Dove Grey K93  | LKB36093 | 391,-  |
| Champagne K95  | LKB36095 | 391,-  |
| White K96      | LKB36096 | 391,-  |
| Light Grey K97 | LKB36097 | 391,-  |
| Dark Grey K99  | LKB36099 | 391,-  |

### GRANITEK

| GRANITEK      |          | Cena € |
|---------------|----------|--------|
| Titanium M73  | LMB36073 | 319,-  |
| Aluminium M79 | LMB36079 | 319,-  |

| MATĒTS       |          | Cena € |
|--------------|----------|--------|
| Nero G40     | LGB36040 | 319,-  |
| Tortora G43  | LGB36043 | 319,-  |
| Cemento G48  | LGB36048 | 319,-  |
| Bianco G68   | LGB36068 | 319,-  |
| Espresso G78 | LGB36078 | 319,-  |

| KLASISKS          |          | Cena € |
|-------------------|----------|--------|
| Avena G51         | LGB36051 | 319,-  |
| Antracite G59     | LGB36059 | 319,-  |
| Bianco Antico G62 | LGB36062 | 319,-  |

## BEST 130



WHITE  
K96

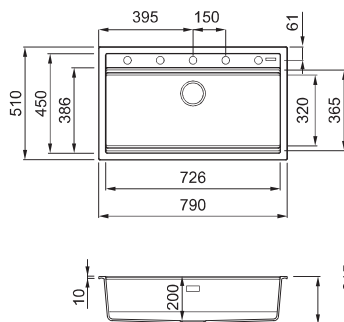

### PAPILDUS



112. Lpp.



Izmērs (mm) **790 x 510**  
 Skapiša platums (mm) **800**  
 Izgriezums (mm) **770 x 480**  
 Bļodas dziļums (mm) **200**  
 Montāžas veids **legriezama**

### IETEICAMIE PIEDERUMI

|     |    |    |    |     |     |     |
|-----|----|----|----|-----|-----|-----|
| 93  | 97 | 25 | 50 | 153 | 156 | 163 |
| 164 | 5  | 75 |    |     |     |     |

### MATERIĀLS UN KRĀSAS

| KERATEK        |          | Cena € |
|----------------|----------|--------|
| Black K86      | LKB13086 | 379,-  |
| Dove Grey K93  | LKB13093 | 379,-  |
| Champagne K95  | LKB13095 | 379,-  |
| White K96      | LKB13096 | 379,-  |
| Light Grey K97 | LKB13097 | 379,-  |
| Dark Grey K99  | LKB13099 | 379,-  |

### GRANITEK

| GRANITEK      |          | Cena € |
|---------------|----------|--------|
| Titanium M73  | LMB13073 | 319,-  |
| Aluminium M79 | LMB13079 | 319,-  |

| MATĒTS       |          | Cena € |
|--------------|----------|--------|
| Nero G40     | LGB13040 | 319,-  |
| Tortora G43  | LGB13043 | 319,-  |
| Cemento G48  | LGB13048 | 319,-  |
| Bianco G68   | LGB13068 | 319,-  |
| Espresso G78 | LGB13078 | 319,-  |

| KLASISKS          |          | Cena € |
|-------------------|----------|--------|
| Avena G51         | LGB13051 | 319,-  |
| Antracite G59     | LGB13059 | 319,-  |
| Bianco Antico G62 | LGB13062 | 319,-  |



Flow-Pro noplūdes sistēma Melnā atētā krāsā



Flow-Pro noplūdes sistēma Slīpēta zelta krāsā

## OPEN UP



Open - Up ir ērta, eleganta spiedpoga atkritumiem, vienkārši nospiežot pogu, neiemērcot roku bļodā ļauj automātiski atvērt un aizvērt noteces korķi.



## BEST 105 JAUNS



Black  
K86

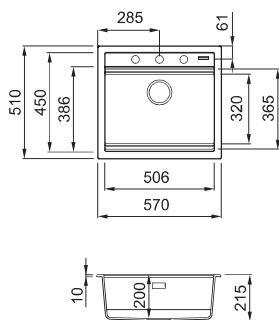

Izmērs (mm) **570 x 510**  
Skapiša platums (mm) **600**  
Izgriezums (mm) **550 x 480**  
Bļodas dziļums (mm) **200**  
Montāžas veids **iegriezama**

### IETEICAMIE PIEDERUMI

|     |    |    |    |     |     |
|-----|----|----|----|-----|-----|
| 93  | 97 | 25 | 50 | 153 | 163 |
| 164 | 5  | 75 | 71 | 9   |     |

### MATERIĀLS UN KRĀSAS

| KERATEK        |          | Cena € |
|----------------|----------|--------|
| Black K86      | LKB10586 | 348,-  |
| Dove Grey K93  | LKB10593 | 348,-  |
| Champagne K95  | LKB10595 | 348,-  |
| White K96      | LKB10596 | 348,-  |
| Light Grey K97 | LKB10597 | 348,-  |
| Dark Grey K99  | LKB10599 | 348,-  |

### METĀLISKS

| GRANITEK      |          | Cena € |
|---------------|----------|--------|
| Titanium M73  | LMB10573 | 286,-  |
| Aluminium M79 | LMB10579 | 286,-  |

### MATĒTS

|              |          |       |
|--------------|----------|-------|
| Nero G40     | LGB10540 | 286,- |
| Tortora G43  | LGB10543 | 286,- |
| Cemento G48  | LGB10548 | 286,- |
| Bianco G68   | LGB10568 | 286,- |
| Espresso G78 | LGB10578 | 286,- |

### KLASISKS

|                   |          |       |
|-------------------|----------|-------|
| Avena G51         | LGB10551 | 286,- |
| Antracite G59     | LGB10559 | 286,- |
| Bianco Antico G62 | LGB10562 | 286,- |

## BEST 104 JAUNS



Black  
K86

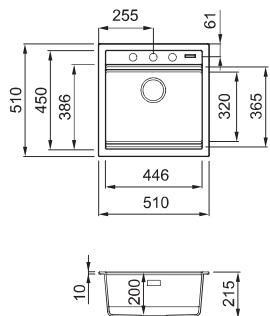

Izmērs (mm) **510 x 510**  
Skapiša platums (mm) **500 III 600 ja pirmais skapis**  
Izgriezums (mm) **490 x 480**  
Bļodas dziļums (mm) **200**  
Montāžas veids **iegriezama**

### IETEICAMIE PIEDERUMI

|     |    |    |    |     |     |     |
|-----|----|----|----|-----|-----|-----|
| 93  | 97 | 25 | 50 | 153 | 156 | 163 |
| 164 | 5  | 75 | 71 | 9   |     |     |

### MATERIĀLS UN KRĀSAS

| KERATEK        |          | Cena € |
|----------------|----------|--------|
| Black K86      | LKB10486 | 336,-  |
| Dove Grey K93  | LKB10493 | 336,-  |
| Champagne K95  | LKB10495 | 336,-  |
| White K96      | LKB10496 | 336,-  |
| Light Grey K97 | LKB10497 | 336,-  |
| Dark Grey K99  | LKB10499 | 336,-  |

### METĀLISKS

| GRANITEK      |          | Cena € |
|---------------|----------|--------|
| Titanium M73  | LMB10473 | 274,-  |
| Aluminium M79 | LMB10479 | 274,-  |

### MATĒTS

|              |          |       |
|--------------|----------|-------|
| Nero G40     | LGB10440 | 274,- |
| Tortora G43  | LGB10443 | 274,- |
| Cemento G48  | LGB10448 | 274,- |
| Bianco G68   | LGB10468 | 274,- |
| Espresso G78 | LGB10478 | 274,- |

### KLASISKS

|                   |          |       |
|-------------------|----------|-------|
| Avena G51         | LGB10451 | 274,- |
| Antracite G59     | LGB10459 | 274,- |
| Bianco Antico G62 | LGB10462 | 274,- |



Izlietne Best 130 | Maisītājs Wave Black BK

KOLEKCIJA  
**BEST-F**



PAPILDUS  
INFORMĀCIJA  
BEST-F



**NEVAINOJAMS EFEKTS**

Īpašā Elleci Workstation versija ar montāžu vienā līmenī ar virsmu, piedāvā tādas pašas funkcijas kā Best WS kolekcija, taču rada perfektu gludumu ar darba virsmu. Nevainojams efekts, lai bagātinātu virtuves stilu.

PLUS **BEST-F**



ELEMENT  
PIEDERUMI



FLOW-PRO



3 LĪMEŅI

**GRANITEK**  
NATURAL GRANITE EFFECT



**KERATEK**  
CERAMIC NANOTECHNOLOGY CN6



## MODELIS BEST-F

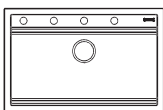

BEST-F 130

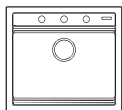

BEST-F 105



BEST-F 104

**Komplektā:** Vietu taupošs sifons, integrēts Flow-Pro noplūde, taisnstūrveida pārplūde un montāžas āķi.

## IETEICAMIE PIEDERUMI

93

### BEST GRIEŽAMĀIS DĒLIS ELEMENT

ATH073QU  
109. Lpp.



#### Apdare



156

### LOKANAIS PAKLĀJS FLEX 500 ELEMENT

ARS023BK  
110. Lpp.



#### Apdare



153

### BEST CAURDURIS

AVP034BK  
110. Lpp.



#### Apdare



97

### SPIEDPOGA ELEMENT

ASP13002BK  
113. Lpp.



#### Apdare



\*Lai iegūtu plašāku informāciju, skatiet piederumu sadaļu 106. lappusē

## PERFEKTI SADERĪGS VIRTUVES MAISĪTĀJS



### WAVE – Black BK MOKWAVBK

120. Lpp.

Pieejamās krāsas



## PAPILDUS

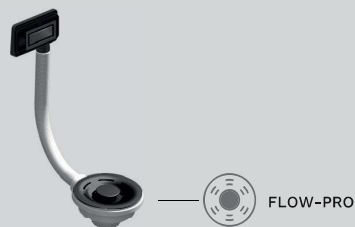

### ELEMENT KOMPLEKTS MELNS FLOW-PRO + PĀRPLŪDE KITWPT-F-1VSL-BK

142. Lpp.

## elleci | BEAUTY



Produktu linija, kas īpaši izstrādāta kompozitmateriālu izlietņu kopšanai.

Vairāk informācijas 140. lpp.

## BEST-F 130 JAUNS



White  
K96

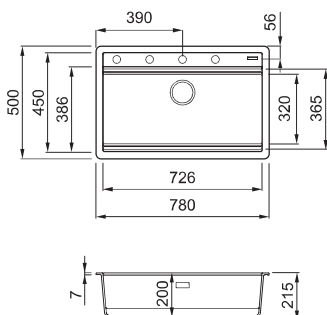

Izmērs (mm) **780 x 500**  
 Skapiša platums (mm) **800**  
 Izgriezums (mm) **Pēc šablona\***  
 Bļodas dziļums (mm) **200**  
 Montāžas veids **Lidzeni montējama**

### IETEICAMIE PIEDERUMI

|     |    |    |    |     |     |     |
|-----|----|----|----|-----|-----|-----|
| 93  | 97 | 25 | 50 | 153 | 156 | 163 |
| 164 | 5  | 75 | 71 | 9   |     |     |

### MATERIĀLS UN KRĀSAS

| KERATEK      |             | Cena € |
|--------------|-------------|--------|
| Black<br>K86 | LKB13086F01 | 402,-  |
| White<br>K96 | LKB13096F01 | 402,-  |

| GRANITEK               |             |       |
|------------------------|-------------|-------|
| NATURAL GRANITE EFFECT |             |       |
| Nero<br>G40            | LGB13040F01 | 338,- |
| Bianco<br>G68          | LGB13068F01 | 338,- |

MATĒTS

## BEST-F 105 JAUNS



White  
K96

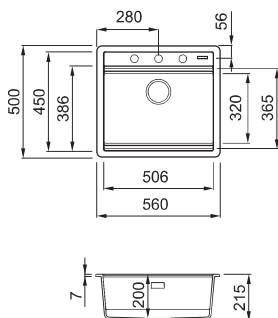

Izmērs (mm) **560 x 500**  
 Skapiša platums (mm) **600**  
 Izgriezums (mm) **Pēc šablona\***  
 Bļodas dziļums (mm) **200**  
 Montāžas veids **Lidzeni montējama**

### IETEICAMIE PIEDERUMI

|     |    |    |    |     |     |     |
|-----|----|----|----|-----|-----|-----|
| 93  | 97 | 25 | 50 | 153 | 156 | 163 |
| 164 | 5  | 75 | 71 | 9   |     |     |

### MATERIĀLS UN KRĀSAS

| KERATEK      |             | Cena € |
|--------------|-------------|--------|
| Black<br>K86 | LKB10586F01 | 369,-  |
| White<br>K96 | LKB10596F01 | 369,-  |

| GRANITEK               |             |       |
|------------------------|-------------|-------|
| NATURAL GRANITE EFFECT |             |       |
| Nero<br>G40            | LGB10540F01 | 305,- |
| Bianco<br>G68          | LGB10568F01 | 305,- |

MATĒTS



# BEST-F 104 JAUNS



White  
K96

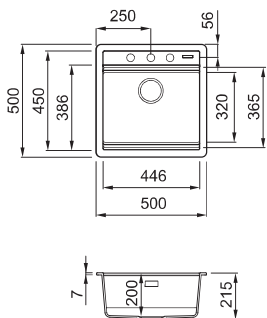

Izmērs (mm) **500 x 500**  
 Skapiša platums (mm) **600**  
 Izgriezums (mm) **pēc šablona\***  
 Bļodas dziļums (mm) **200**  
 Montāžas veids **līdzēni montējama**

### IETEICAMIE PIEDERUMI

|     |    |    |    |     |     |     |
|-----|----|----|----|-----|-----|-----|
| 93  | 97 | 25 | 50 | 153 | 156 | 163 |
| 164 | 5  | 75 | 71 | 9   |     |     |

## elleci | VIRTUVE

### MATERIĀLS UN KRĀSAS

**KERATEK**  
CERAMIC TECHNOLOGY

|                |             | Cena € |
|----------------|-------------|--------|
| ● Black<br>K86 | LKB10486F01 | 356,-  |
| ● white<br>K96 | LKB10496F01 | 356,-  |

**GRANITEK**  
NATURAL GRANITE EFFECT

| MATĒTS          |             |       |
|-----------------|-------------|-------|
| ● Nero<br>G40   | LGB10440F01 | 290,- |
| ● Bianco<br>G68 | LGB10468F01 | 290,- |

VIRTUVES  
IZLIETNES

KOLEKCIJA  
**ZEN**



PAPILDUS  
INFORMĀCIJA  
ZEN



**MAZĀK IR VAIRĀK**

Patiesi mūžīgam dizainam ir jāiztur mainīgās tendences un nemanāmi jāpielāgojas dažādām vīdēm. Mēs esam izstrādājuši jaunu kolekciju, kas uzsver gan Elleci tehnoloģiju, gan tās uzmanību detaļām, kas izceļas konkurentu vidū ar savu daudzpusību. Vārdu sākot... ZEN

PLUS **ZEN**



ELEMENT  
PIEDERUMI



FLOW-PRO



6 mm  
PLĀNAS  
MALAS

**KERATEK**  
CERAMIC NANOTECHNOLOGY CN6

- Black  
K86
- Dove Grey  
K93
- Champagne  
K95
- White  
K96
- Light Grey  
K97
- Dark Grey  
K99

## MODELIS ZEN

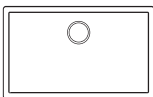

ZEN 130

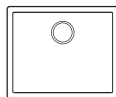

ZEN 105



ZEN 102

**Komplektā:** Vietu taupošs sifons, integrēts Flow-Pro noplūde, taisnstūrveida pārplūde un montāžas āķi.

## IETEICAMIE PIEDERUMU

91

**GRIEŽAMĀIS DĒLIS  
420 ELEMENT**  
ATH040OL  
109. Lpp.



**Apdare**



157

**LOKANĀIS PAKLĀJS  
FLEX 440 ELEMENT**  
ARS013BK  
110. Lpp.



**Apdare**



235

**CAURDURIS  
ELEMENT**  
AVP035BK  
111. Lpp.



**Apdare**



\*Lai iegūtu plašāku informāciju, skatiet piederumu sadaļu **106.** lappusē

## PERFEKTI SADERĪGS VIRTUVES MAISĪTĀJS



**CLUB – Black BK**  
MOKCLUBK

129. Lpp.

Pieejamās krāsas



## PAPILDUS

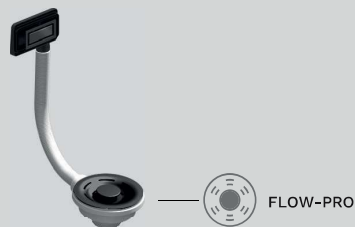

ELEMENT KOMPLEKTS  
**MELNS FLOW-PRO + PĀRPLŪDE**  
Art. KITWPT-F-1VSLL-BK

142. Lpp.

## elleci | BEAUTY



Produktu linija, kas īpaši izstrādāta kompozitmateriālu izlietņu kopšanai.

Vairāk informācijas **142.** Lpp.

## ZEN 130



Dark Grey  
K99

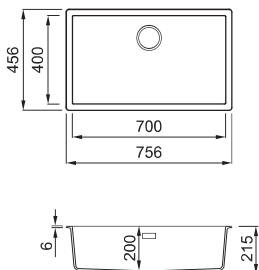

### PAPILDUS



112. Lpp.

### MATERIĀLS UN KRĀSAS

| KERATEK        |          | Cena € |
|----------------|----------|--------|
| Black K86      | LKZ13086 | 396,-  |
| Dove Grey K93  | LKZ13093 | 396,-  |
| Champagne K95  | LKZ13095 | 396,-  |
| White K96      | LKZ13096 | 396,-  |
| Light Grey K97 | LKZ13097 | 396,-  |
| Dark Grey K99  | LKZ13099 | 396,-  |



|                      |                                    |
|----------------------|------------------------------------|
| Izmērs (mm)          | <b>756 x 456</b>                   |
| Skapiša platums (mm) | <b>800</b>                         |
| Izgriezums (mm)      | <b>745 x 445 R5 (iegriežamai)</b>  |
|                      | <b>700 x 400 R10 (pabūvējamai)</b> |
| Bļodas dziļums (mm)  | <b>200</b>                         |
| Montāžas veids       | <b>Iegriežama, Pabūvējama</b>      |

### IETEICAMIE PIEDERUMI

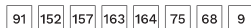

## ZEN 105



Dark Grey  
K99

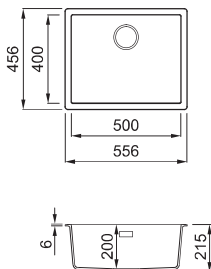

|                      |                                    |
|----------------------|------------------------------------|
| Izmērs (mm)          | <b>556 x 456</b>                   |
| Skapiša platums (mm) | <b>600</b>                         |
| Izgriezums (mm)      | <b>545 x 445 R5 (iegriežamai)</b>  |
|                      | <b>500 x 400 R10 (pabūvējamai)</b> |
| Bļodas dziļums (mm)  | <b>200</b>                         |
| Montāžas veids       | <b>Iegriežama, Pabūvējama</b>      |

### MATERIĀLS UN KRĀSAS

| KERATEK        |          | Cena € |
|----------------|----------|--------|
| Black K86      | LKZ10586 | 358,-  |
| Dove Grey K93  | LKZ10593 | 358,-  |
| Champagne K95  | LKZ10595 | 358,-  |
| White K96      | LKZ10596 | 358,-  |
| Light Grey K97 | LKZ10597 | 358,-  |
| Dark Grey K99  | LKZ10599 | 358,-  |

### IETEICAMIE PIEDERUMI

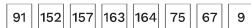

## ZEN 102



Dark Grey  
K89

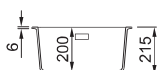
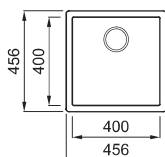

### PAPILDUS



● Melns BK  
● Zelta krāsa GD

112. Lpp.

### MATERIĀLS UN KRĀSAS

KERATEK

www.keratek.com

|                  |          | Cena € |
|------------------|----------|--------|
| ● Black K86      | LKZ10286 | 322,-  |
| ● Dove Grey K93  | LKZ10293 | 322,-  |
| ● Champagne K95  | LKZ10295 | 322,-  |
| ● White K96      | LKZ10296 | 322,-  |
| ● Light Grey K97 | LKZ10297 | 322,-  |
| ● Dark Grey K99  | LKZ10299 | 322,-  |



Izmērs (mm) **456 x 456**  
 Skapiša platums (mm) **450 III 500 ja pirmais skapis (iegriežamā), 500 (pabūvējamā)**  
 Izgriezums (mm) **445 x 445 R5 (iegriežamai), 400 x 400 R10 (pabūvējamai)**  
 Bļodas dziļums (mm) **200**  
 Montāžas veids **iegriežama, Pabūvējama**

### IETEICAMIE PIEDERUMI

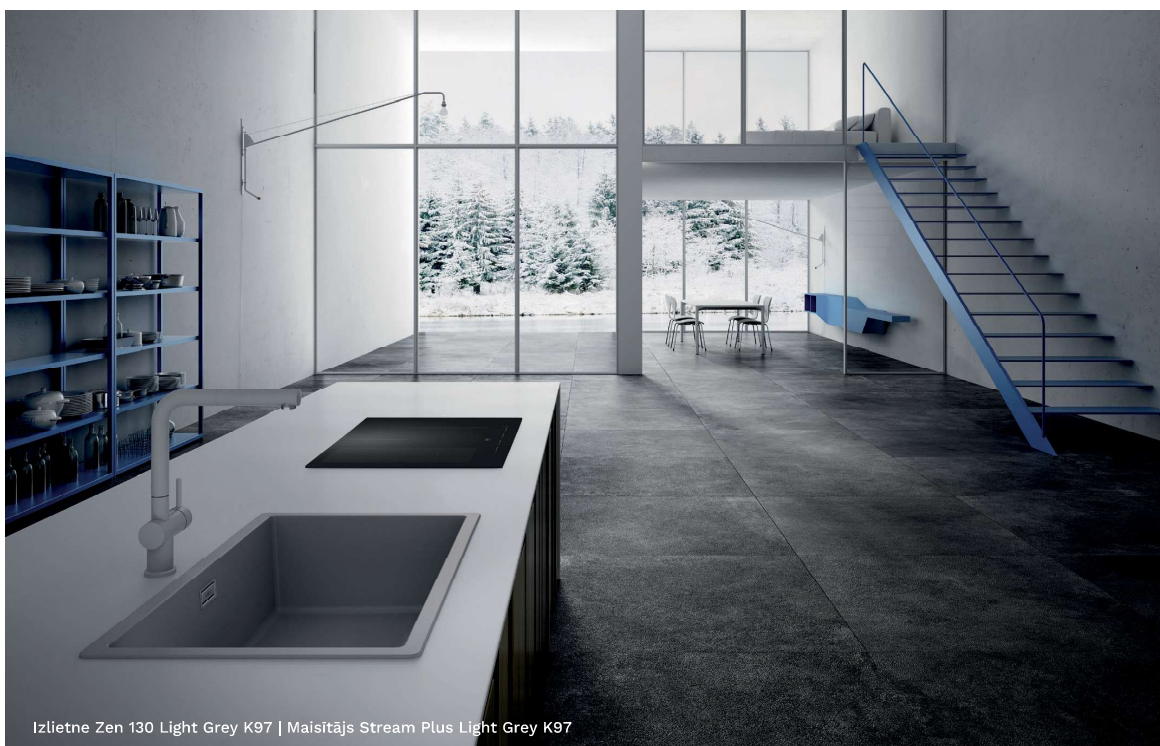
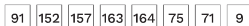

Izlietne Zen 130 Light Grey K97 | Maisītājs Stream Plus Light Grey K97

# KOLEKCIJA ZEN-F



LIDZENI  
MONTĒJAMA

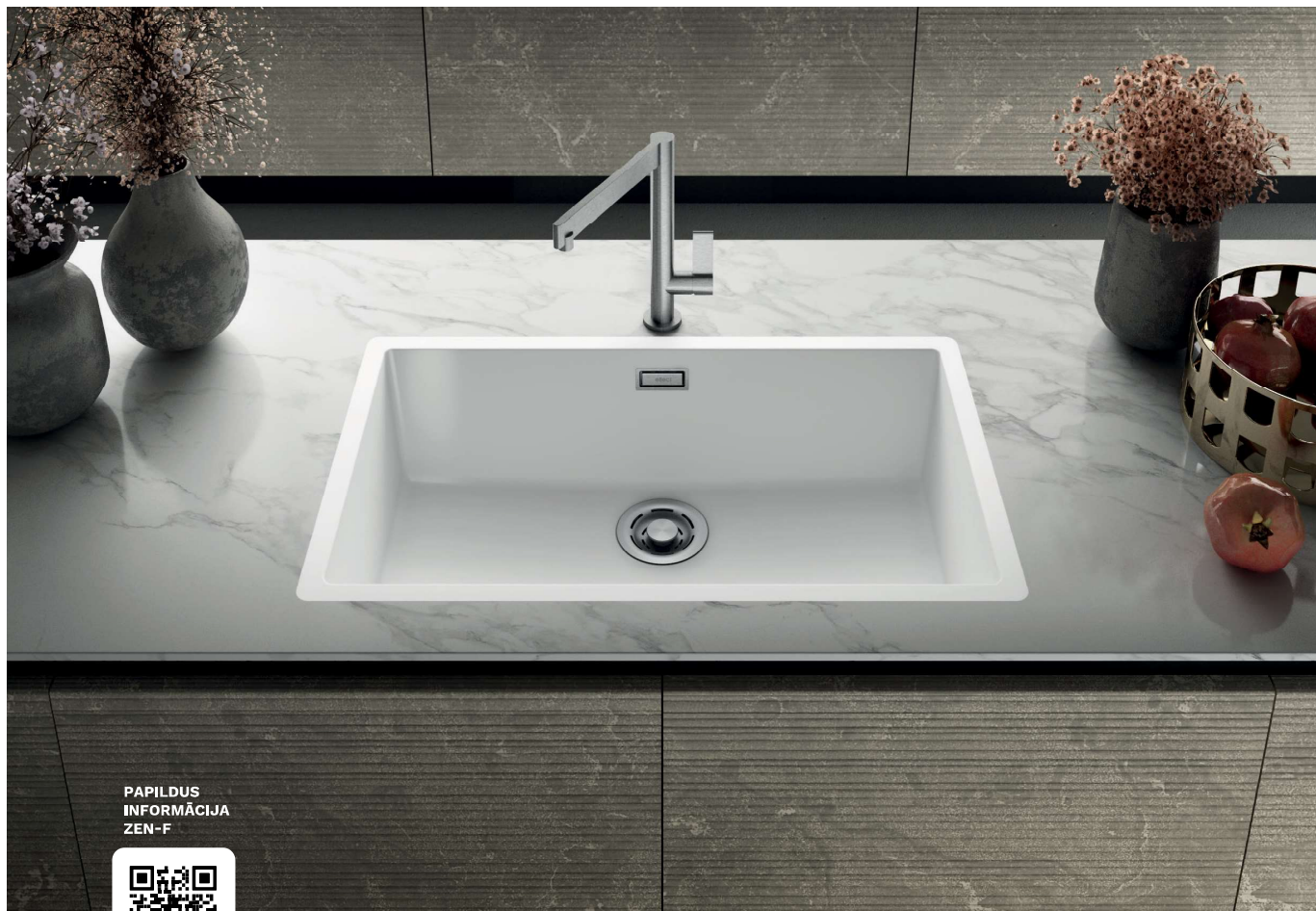

PAPILDUS  
INFORMĀCIJA  
ZEN-F



## ESTĒTIKA BEZ KOMPROMISIEM

Linijas un formas maņu nepārtrauktībā. Izlietņu līnija ar montāžu vienā līmenī ar virsmu, kas uzlabo estētisko pudlīniju starp virsmu un izlietni. Nosaukums, kas apzīmē relaksāciju, precizitāti un tīras līnijas.

## PLUS ZEN-F



ELEMENT  
PIEDERUMI



FLOW-PRO

**KERATEK**  
CERAMIC NANOTECHNOLOGY CN6

-  **Black**  
K86
-  **Dove Grey**  
K93
-  **Champagne**  
K95
-  **White**  
K96
-  **Light Grey**  
K97
-  **Dark Grey**  
K99

## MODELIS ZEN-F

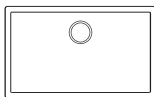

ZEN-F 130

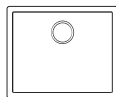

ZEN-F 105



ZEN-F 102

**Komplektā:** Vietu taupošs sifons, integrēts Flow-Pro noplūde, taisnstūrveida pārplūde un montāžas āķi.

## IETEICAMIE PIEDERUMU

91

**GRIEŽAMĀIS DĒLIS  
420 ELEMENT**  
ATH040OL  
109. Lpp.



**Apdare**

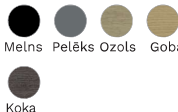

157

**LOKANAIS PAKLĀJS  
FLEX 440 ELEMENT**  
ARS013BK  
110. Lpp.



**Apdare**



152

**CAURDURIS  
ELEMENT**  
AVP035BK  
111. Lpp.



**Apdare**



\*Lai iegūtu plašāku informāciju, skatiet piederumu sadaļu 106. lappusē

## PERFEKTI SADERĪGS VIRTUVES MAISĪTĀJS

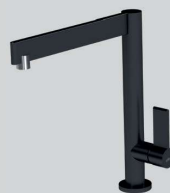

**TEMA – Black K86**  
MKKTEM86

126. Lpp.

Pieejamās krāsas

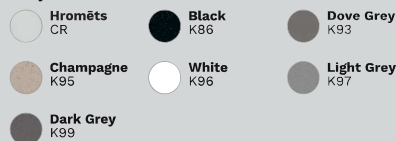

## PAPILDUS

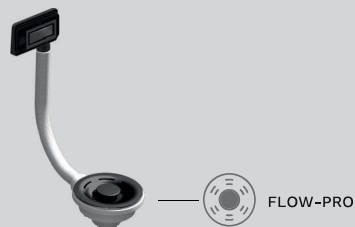

ELEMENT KOMPLEKTS  
**MELNS FLOW-PRO + PĀRPLŪDE**  
Art. KITWPT-F-1VSSL-BK

142. Lpp.

## elleci | BEAUTY



Produktu līnija, kas īpaši izstrādāta kompozitmateriālu izlietņu kopšanai.

Vairāk informācijas 140.lpp.

## ZEN-F 130

JAUNS



Black  
K86

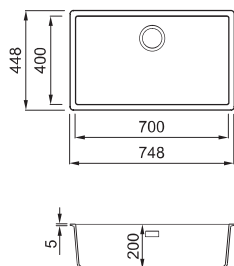

Izmērs (mm) **748 x 448**  
 Skapiša platums (mm) **800**  
 Izgriezums (mm) **Pēc šablona\***  
 Bļodas dziļums (mm) **200**  
 Montāžas veids **Līdzieni montējama**

### PAPILDUS



112. Lpp.

### MATERIĀLS UN KRĀSAS

| KERATEK        |             | Cena € |
|----------------|-------------|--------|
| Black K86      | LKZ13086F01 | 435,-  |
| Dove Grey K93  | LKZ13093F01 | 435,-  |
| Champagne K95  | LKZ13095F01 | 435,-  |
| White K96      | LKZ13096F01 | 435,-  |
| Light Grey K97 | LKZ13097F01 | 435,-  |
| Dark Grey K99  | LKZ13099F01 | 435,-  |

### IETEICAMIE PIEDERUMI

39 44 51

\*Šablons ir iekļauts komplektā vai arī pieejams lejuplādei no vietnes [www.elleci.com/it](http://www.elleci.com/it) īpašās lejupielādes sadaļas

## ZEN-F 105

JAUNS



Black  
K86

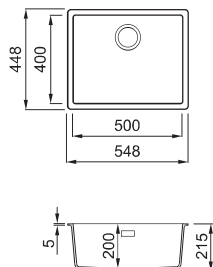

Izmērs (mm) **548 x 448**  
 Skapiša platums (mm) **600**  
 Izgriezums (mm) **Pēc šablona\***  
 Bļodas dziļums (mm) **200**  
 Montāžas veids **Līdzieni montējama**

### MATERIĀLS UN KRĀSAS

| KERATEK        |             | Cena € |
|----------------|-------------|--------|
| Black K86      | LKZ10586F01 | 396,-  |
| Dove Grey K93  | LKZ10593F01 | 396,-  |
| Champagne K95  | LKZ10595F01 | 396,-  |
| White K96      | LKZ10596F01 | 396,-  |
| Light Grey K97 | LKZ10597F01 | 396,-  |
| Dark Grey K99  | LKZ10599F01 | 396,-  |

### IETEICAMIE PIEDERUMI

39 44 51

\*Šablons ir iekļauts komplektā vai arī pieejams lejuplādei no vietnes [www.elleci.com/it](http://www.elleci.com/it) īpašās lejupielādes sadaļas



## ZEN-F 102

JAUNS



Black  
K86

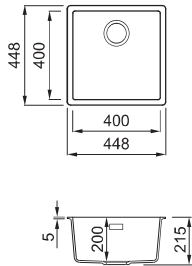

### PAPILDUS



112. Lpp.

## elleci | VIRTUVE

### MATERIĀLS UN KRĀSAS

| KERATEK           |             | Cena € |
|-------------------|-------------|--------|
| Black<br>K86      | LKZ10286F01 | 356,-  |
| Dove Grey<br>K93  | LKZ10293F01 | 356,-  |
| Champagne<br>K95  | LKZ10295F01 | 356,-  |
| White<br>K96      | LKZ10296F01 | 356,-  |
| Light Grey<br>K97 | LKZ10297F01 | 356,-  |
| Dark Grey<br>K99  | LKZ10299F01 | 356,-  |



Izmērs (mm) **448 x 448**  
 Skapiša platums **500**  
 Izgriezums (mm) **Pēc šablona\***  
 Bļodas dziļums (mm) **200**  
 Montāžas veids **Līdzieni montējama**

### IETEICAMIE PIEDERUMI



\*Šablons ir iekļauts komplektā vai arī pieejams lejupielādei no vietnes [www.elleci.com/it](http://www.elleci.com/it) ci. [www.elleci.com/it](http://www.elleci.com/it) īpašās lejupielādes sadaļās



Izlietne Zen-F 105 Light Grey K97| Maisītājs Wave Black BK

KOLEKCIJA  
**KARISMA**



PAPILDUS  
INFORMĀCIJA  
KARISMA



**HARIZMĀTISKAIS DIZAINS**

"Nošķeltā" mala, kas veicina harmoniskāku izlietnes lietošanu. Dizains ir funkcionāls un praktisks, taču tajā joprojām ir taisnas, treknas līnijas. 45° iekšējais slīpums, kas savieno malu ar iekšējo bļodu, atvieglo TĪRĪŠANU un GATAVOŠANU, mazgāšanas zonā.

PLUS **KARISMA**



KANTAINA  
NOPLŪDE



TAISNISTŪRA  
PĀRPLŪDE



INTEGRĒTA  
PIEDERUMU  
ZONA



K MALAS

**GRANITEK**  
NATURAL GRANITE EFFECT

- **Titanium**  
M73
- **Aluminium**  
M79
- **Nero**  
G40
- **Tortora**  
G43
- **Bianco**  
G68

## MODELIS KARISMA

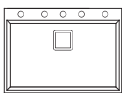

KARISMA 120

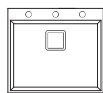

KARISMA 105

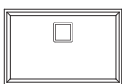

KARISMA 120  
PABŪVĒJAMA

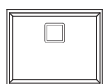

KARISMA 105  
PABŪVĒJAMA

**Komplektā:** Vietu taupošs sifons, kvadrātveida noplūde, taisnstūra pārplūde un montāžas āķi.

## IETEICAMIE PIEDERUMU

88

### GRIEŽAMĀIS DĒLIS ELEMENT

ATH010QU  
108. Lpp.



#### Apdare



5

### CAURDURIS

AVI03001  
116. Lpp.



157

### LOKANĀIS PAKLĀJS FLEX 440 ELEMENT

ARS013BK  
110. Lpp.



#### Apdare



75

### GROZS

ACI01307  
117. Lpp.



\*Lai iegūtu plašāku informāciju, skatiet piederumu sadaļu 106. lappusē

## PERFEKTI SADERĪGS VIRTUVES MAISĪTĀJS



### TOURMALINE – Nero G40 MGKT0140

122. Lpp.

#### Pieejamās krāsas

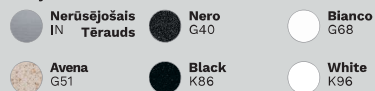

## PAPILDUS



### ELEMENT KOMPLEKTS KANTAINS ZIEPJU DOZATORS ELEMENT Art.ADI02301

111. Lpp.

## elleci | BEAUTY



Produktu linija, kas īpaši izstrādāta kompozitmateriālu izlietņu kopšanai.

Vairāk informācijas 140.lpp.

## KARISMA 120



Bianco  
G68

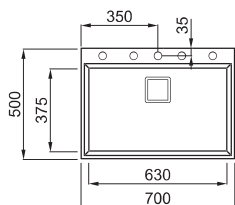

Izmērs (mm) **700 x 500**  
 Skapiša platums (mm) **800**  
 Izgriezums (mm) **680 x 480**  
 Bļodas dziļums (mm) **220**  
 Montāžas veids **legriežama**

### IETEICAMIE PIEDERUMI

88 98 50 157 4 5 75 68 9

### MATERIĀLS UN KRĀSAS

| METĀLISKS |   | GRANITEK  | NATURAL GRANITE EFFECT | Cena € |
|-----------|---|-----------|------------------------|--------|
| METĀLISKS | ● | Titanium  | LMK12073               | 395,-  |
|           | ● | Aluminium | LMK12079               | 395,-  |
| MATĒTS    | ● | Nero      | LGK12040               | 395,-  |
|           | ● | Tortora   | LGK12043               | 395,-  |
|           | ● | Bianco    | LGK12068               | 395,-  |

## KARISMA 105



Bianco  
G68

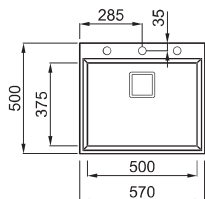

Izmērs (mm) **570 x 500**  
 Skapiša platums (mm) **600**  
 Izgriezums (mm) **550 x 480**  
 Bļodas dziļums (mm) **220**  
 Montāžas veids **legriežama**

### IETEICAMIE PIEDERUMI

88 98 50 157 4 5 75 71 9

### MATERIĀLS UN KRĀSAS

| METĀLISKS |   | GRANITEK  | NATURAL GRANITE EFFECT | Cena € |
|-----------|---|-----------|------------------------|--------|
| METĀLISKS | ● | Titanium  | LMK10573               | 332,-  |
|           | ● | Aluminium | LMK10579               | 332,-  |
| MATĒTS    | ● | Nero      | LGK10540               | 332,-  |
|           | ● | Tortora   | LGK10543               | 332,-  |
|           | ● | Bianco    | LGK10568               | 332,-  |

## KARISMA 120 PABŪVĒJAMS



Titanium  
M73

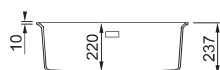
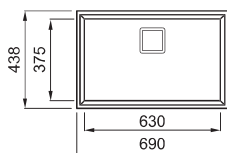

Izmērs (mm) **690 x 438**  
 Skapiša platums (mm) **800**  
 Izgriezums (mm) **664 x 411 R5**  
 Blodas dziļums (mm) **220**  
 Montāžas veids **Pabūvējama**

### IETEICAMIE PIEDERUMI

157 75 68 9

### MATERIĀLS UN KRĀSAS

| METĀLISKS |  | GRANITEK<br><small>NATURAL GRANITE EFFECT</small> |             | Cena € |
|-----------|--|---|-------------|--------|
| METĀLISKS |  | Titanium<br>M73                                   | LMK12073BSO | 410,-  |
|           |  | Aluminium<br>M79                                  | LMK12079BSO | 410,-  |
| MATĒTS    |  | Nero<br>G40                                       | LGK12040BSO | 410,-  |
|           |  | Tortora<br>G43                                    | LGK12043BSO | 410,-  |
|           |  | Bianco<br>G68                                     | LGK12068BSO | 410,-  |

## KARISMA 105 PABŪVĒJAMS



Titanium  
M73

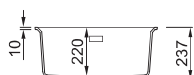
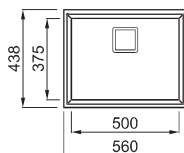

Izmērs (mm) **560 x 438**  
 Skapiša platums (mm) **600**  
 Izgriezums (mm) **534 x 411 R5**  
 Blodas dziļums (mm) **220**  
 Montāžas veids **Pabūvējama**

### IETEICAMIE PIEDERUMI

157 75 71 9

### MATERIĀLS UN KRĀSAS

| METĀLISKS |  | GRANITEK<br><small>NATURAL GRANITE EFFECT</small> |             | Cena € |
|-----------|--|---|-------------|--------|
| METĀLISKS |  | Titanium<br>M73                                   | LMK10573BSO | 340,-  |
|           |  | Aluminium<br>M79                                  | LMK10579BSO | 340,-  |
| MATĒTS    |  | Nero<br>G40                                       | LGK10540BSO | 340,-  |
|           |  | Tortora<br>G43                                    | LGK10543BSO | 340,-  |
|           |  | Bianco<br>G68                                     | LGK10568BSO | 340,-  |

KOLEKCIJA  
**INTEGRA**



PAPILDUS  
INFORMĀCIJA  
INTEGRA



**MODERNS DIZAINS, KAS PIERĀDA IZCĪLĪBU**

Montāžas līnija ar iespēju integrēt darba virsmās. Tāds komponents kā jaunā FLOW-PRO ūdens noplūde un taisnstūrveida pārplūdes izmantošana, kopā piešķir šai kolekcijai elegantu, minimālistisku izskatu.

PLUS **INTEGRA**



NEREDZAMS  
SAVIEŅOJUMS



TAISNSTŪRA  
PĀRPLŪDE

**KERATEK**<sup>®</sup>  
CERAMIC NANOTECHNOLOGY CN6

- **Black**  
K86
- **Dove Grey**  
K93
- **White**  
K96
- **Dark Grey**  
K99

## MODELIS INTEGRA

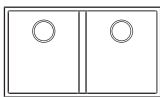

INTEGRA 350

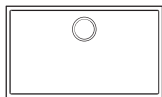

INTEGRA 130

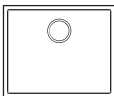

INTEGRA 105



INTEGRA 102

**Komplektā:** Vietu taupošs sifons, integrēts Flow-Pro noplūde, taisnstūrveida pārplūde un montāžas āķi.

## IETEICAMIE PIEDERUMI

91

**GRIEŽAMĀIS DĒLIS  
420 ELEMENT**  
ATH040OL  
109. Lpp.



**Apdare**

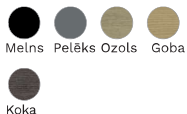

157

**LOKANĀIS PAKLĀJS  
FLEX 440 ELEMENT**  
ARS013BK  
110. Lpp.



**Apdare**



152

**CAURDURIS  
418 ELEMENT**  
AVP035BK  
111. Lpp.



**Apdare**



68

**IZLIETNES PAMATNES  
METĀLA REŽĢIS**  
AGB01303  
116. Lpp.

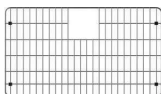

\*Lai iegūtu plašāku informāciju, skatiet piederumu sadaļu 106. lappusē

## PERFEKTI SADERĪGS VIRTUVES MAISĪTĀJS



**TRAIL – Nero G40**  
MGKTRA40

125. Lpp.

Pieejamās krāsas



## PAPILDUS

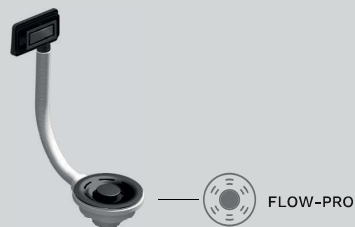

ELEMENT KOMPLEKTS  
**MELNS FLOW-PRO + PĀRPLŪDE**  
Art. KITWPT-F-IVSLL-BK

142. Lpp.

## elleci | BEAUTY



Produktu līnija, kas īpaši izstrādāta kompozitmateriālu izlietņu kopšanai.

Vairāk informācijas 140.lpp.

## INTEGRA 350



White  
K96

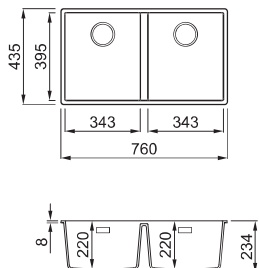

### PAPILDUS



Melns BK      Zelta krāsa GD

112. Lpp.

### MATERIĀLS UN KRĀSAS

| KERATEK       |             | Cena € |
|---------------|-------------|--------|
| Black K86     | LKQ35086BIN | 460,-  |
| Dove Grey K93 | LKQ35093BIN | 460,-  |
| White K96     | LKQ35096BIN | 460,-  |
| Dark Grey K99 | LKQ35099BIN | 460,-  |



Izmērs (mm) **760 x 435**  
 Skapiša platums (mm) **800**  
 Izgriezums (mm) **720 x 395 R5**  
 Bļodas 1 dziļums (mm) **220**  
 Bļodas 2 dziļums (mm) **220**  
 Montāžas veids **Integrējama Pabūvējama**

### IETEICAMIE PIEDERUMI

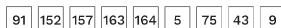

## INTEGRA 130



White  
K96

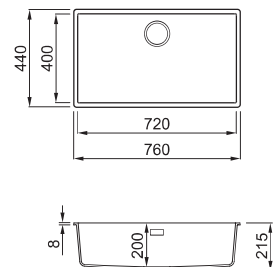

Izmērs (mm) **760 x 440**  
 Skapiša platums (mm) **800**  
 Izgriezums (mm) **720 x 400 R5**  
 Bļodas dziļums (mm) **200**  
 Montāžas veids **Integrējama Pabūvējama**

### MATERIĀLS UN KRĀSAS

| KERATEK       |             | Cena € |
|---------------|-------------|--------|
| Black K86     | LKQ13086BIN | 392,-  |
| Dove Grey K93 | LKQ13093BIN | 392,-  |
| White K96     | LKQ13096BIN | 392,-  |
| Dark Grey K99 | LKQ13099BIN | 392,-  |

### IETEICAMIE PIEDERUMI

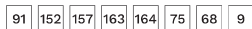



elleci | VIRTUVE

INTEGRA 105



Dark Grey  
K99

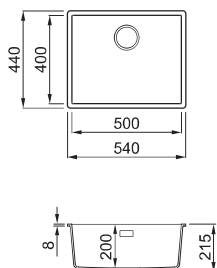

PAPILDUS



112. Lpp.

MATERIĀLS UN KRĀSAS

| KERATEK       |             | Cena € |
|---------------|-------------|--------|
| Black K86     | LKQ10586BIN | 344,-  |
| Dove Grey K93 | LKQ10593BIN | 344,-  |
| White K96     | LKQ10596BIN | 344,-  |
| Dark Grey K99 | LKQ10599BIN | 344,-  |



Izmērs (mm) **540 x 440**  
 Skapiša platums (mm) **600**  
 Izgriezums (mm) **500 x 400 R5**  
 Bļodas dziļums (mm) **200**  
 Montāžas veids **Integrējama Pabūvējama**

IETEICAMIE PIEDERUMI

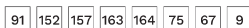

INTEGRA 102



Dark Grey  
K99

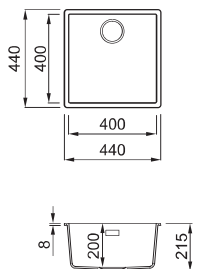

MATERIĀLS UN KRĀSAS

| KERATEK       |             | Cena € |
|---------------|-------------|--------|
| Black K86     | LKQ10286BIN | 343,-  |
| Dove Grey K93 | LKQ10293BIN | 343,-  |
| White K96     | LKQ10296BIN | 343,-  |
| Dark Grey K99 | LKQ10299BIN | 343,-  |



Izmērs (mm) **440 x 440**  
 Skapiša platums (mm) **500**  
 Izgriezums (mm) **400 x 400 R5**  
 Bļodas dziļums (mm) **200**  
 Montāžas veids **Integrējama Pabūvējama**

IETEICAMIE PIEDERUMI

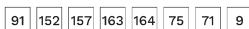

KOLEKCIJA  
**QUADRA**

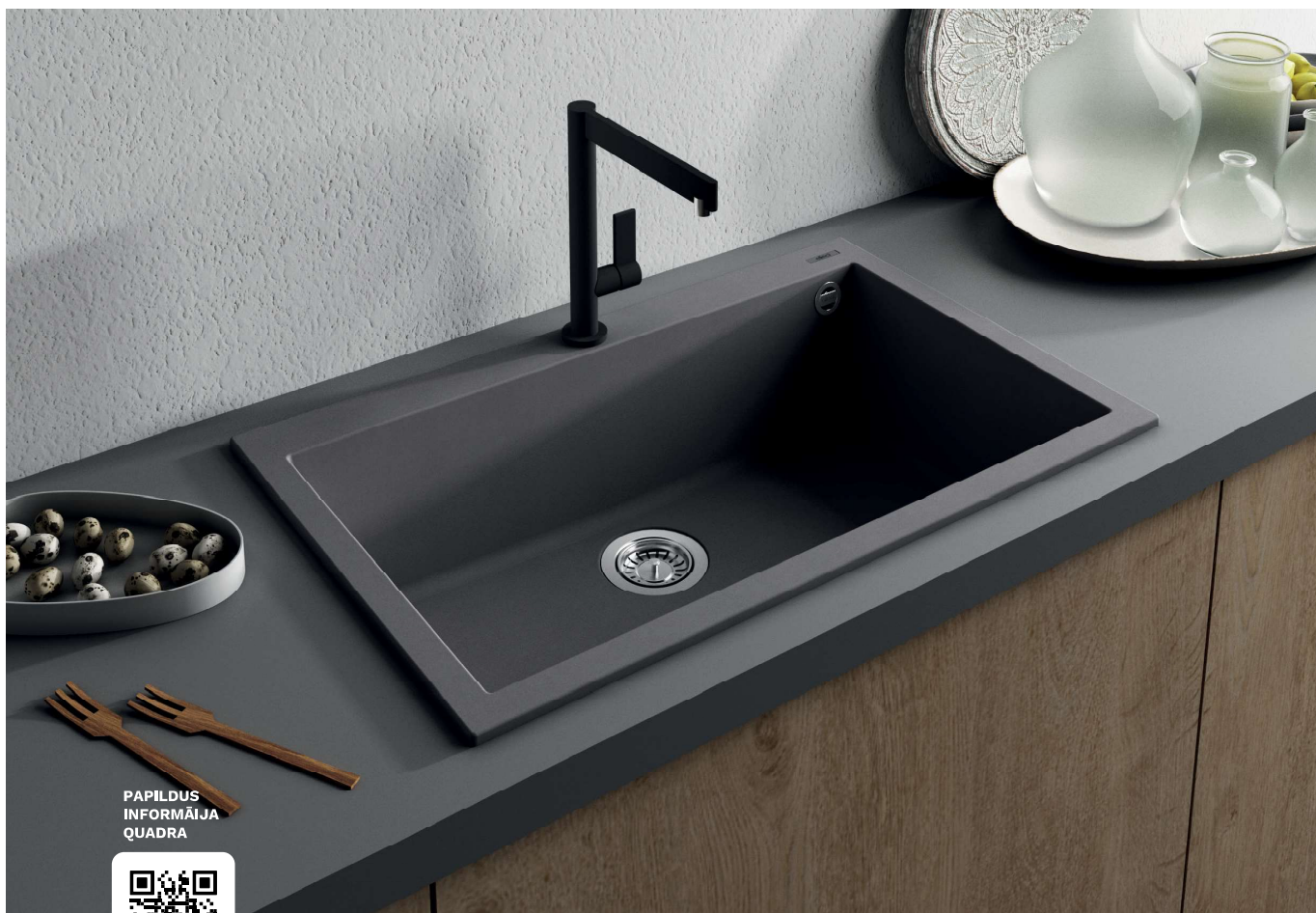

PAPILDUS  
INFORMĀIJA  
QUADRA



**MINIMĀLISMA DIZAINS UN MŪDIENU STILS**

Minimālisma kolekcija ar vienkāršību, kas izceļ tās tīrās, modernās līnijas. Katru modeli var kombinēt ar dažādu aksesuāru klāstu un dažādām krāsām.

PLUS **QUADRA**



ELEMENT  
PIEDERUMI



INTEGRĒTA  
PIEDERUMU  
ZONA

**GRANITEK**  
NATURAL GRANITE EFFECT

● **Nero Metal**  
M70

● **Titanium**  
M73

● **Aluminium**  
M79

● **Nero**  
G40

● **Tortora**  
G43

● **Cemento**  
G48

○ **4D6B79**  
G68

● **Espresso**  
G78

● **Avena**  
G51

● **Antracite**  
G59

● **Bianco Antico**  
G62

**KERATEK**  
CERAMIC NANOTECHNOLOGY CN6

● **Black**  
K86

● **Dove Grey**  
K93

● **Champagne**  
K95

● **White**  
K96

● **Light Grey**  
K97

● **Dark Grey**  
K99

## MODELIS QUADRA

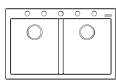

QUADRA 350



QUADRA 150

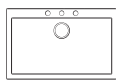

QUADRA 130



QUADRA 110



QUADRA 105



QUADRA 102



QUADRA 100



QUADRA 50

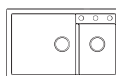

QUADRA 440

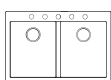

QUADRA 340

**Komplektā:** Vietu taupošs sifons, ventiļu sistēma ar apaļu pārplūdi un montāžas āķi.

## IETEICAMIE PIEDERUMI

91

**GRIEŽAMĀIS DĒLĪS  
410 ELEMENT**  
ATH040OL  
109. Lpp.



**Apdare**

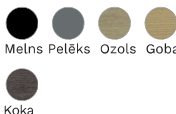

157

**LOKANĀIS PAKLĀJS  
FLEX 440 ELEMENT**  
ARS013BK  
110. Lpp.



**Apdare**



152

**CAURDURIS  
418 ELEMENT**  
AVP035BK  
111. Lpp.



**Apdare**



25

**ZIEPJU DOZATORS  
ELEMENT**  
ADI02300BK  
111. Lpp.



**Apdare**



\*Lai iegūtu plašāku informāciju, skatiet piederumu sadaļu 106. lappusē

## PERFEKTI SADERĪGS VIRTUVES MAISĪTĀJS

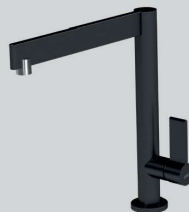

**TEMA – Black BK**  
MOKTEMBK

126. Lpp.

Pieejamās krāsas



## PAPILDUS



**ELEMENT KOMPLEKTS  
VADĪBAS KONTROLE ATVER  
PAGRIEŽOT OPEN-TWIST ELEMENT**  
Art. KITASP-FB-IVTELL-IN

114. Lpp.

## elleci | BEAUTY



Produktu linija, kas īpaši izstrādāta kompozitmateriālu izlietņu kopšanai.

Vairāk informācijas 140.lpp.

## QUADRA 130



Bianco  
G68

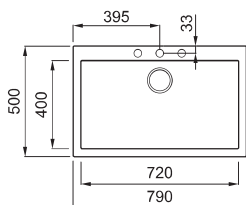

Izmērs (mm) **790 x 500**  
Skapiša platums (mm) **800**  
Izgriezums (mm) **770 x 480**  
Bļodas dziļums (mm) **200**  
Montāžas veids **legriežama**

### IETEICAMIE PIEDERUMI

|    |    |    |    |     |     |     |
|----|----|----|----|-----|-----|-----|
| 91 | 97 | 25 | 50 | 152 | 157 | 163 |
| 4  | 5  | 75 | 68 | 9   | 194 | 195 |

### MATERIĀLS UN KRĀSAS

| KERATEK        |          | Cena € |
|----------------|----------|--------|
| Black K86      | LKQ13086 | 346,-  |
| Dove Grey K93  | LKQ13093 | 346,-  |
| Champagne K95  | LKQ13095 | 346,-  |
| White K96      | LKQ13096 | 346,-  |
| Light Grey K97 | LKQ13097 | 346,-  |
| Dark Grey K99  | LKQ13099 | 346,-  |

### GRANITEK

| GRANITEK               |                   | Cena €   |       |
|------------------------|-------------------|----------|-------|
| NATURAL GRANITE EFFECT |                   |          |       |
| METĀLISKS              | Nero Metal M70    | LMQ13070 | 280,- |
|                        | Titanium M73      | LMQ13073 | 280,- |
|                        | Aluminium M79     | LMQ13079 | 280,- |
| MATĒTS                 | Nero G40          | LGQ13040 | 280,- |
|                        | Tortora G43       | LGQ13043 | 280,- |
|                        | Cemento G48       | LGQ13048 | 280,- |
|                        | Bianco G68        | LGQ13068 | 280,- |
|                        | Espresso G78      | LGQ13078 | 280,- |
| KLASISKS               | Avena G51         | LGQ13051 | 280,- |
|                        | Antracite G59     | LGQ13059 | 280,- |
|                        | Bianco Antico G62 | LGQ13062 | 280,- |

## QUADRA 110



Bianco  
G68

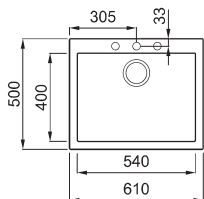

Izmērs (mm) **610 x 500**  
Skapiša platums (mm) **600 ||| 800 ja pirmais skapis**  
Izgriezums (mm) **590 x 480**  
Bļodas dziļums (mm) **190**  
Montāžas veids **legriežama**

### IETEICAMIE PIEDERUMI

|    |    |    |    |     |     |     |
|----|----|----|----|-----|-----|-----|
| 91 | 97 | 25 | 50 | 152 | 157 | 163 |
| 4  | 5  | 75 | 67 | 9   | 194 | 195 |

### MATERIĀLS UN KRĀSAS

| KERATEK        |          | Cena € |
|----------------|----------|--------|
| Black K86      | LKQ11086 | 327,-  |
| Dove Grey K93  | LKQ11093 | 327,-  |
| Champagne K95  | LKQ11095 | 327,-  |
| White K96      | LKQ11096 | 327,-  |
| Light Grey K97 | LKQ11097 | 327,-  |
| Dark Grey K99  | LKQ11099 | 327,-  |

### GRANITEK

| GRANITEK               |                   | Cena €   |       |
|------------------------|-------------------|----------|-------|
| NATURAL GRANITE EFFECT |                   |          |       |
| METĀLISKS              | Nero Metal M70    | LMQ11070 | 260,- |
|                        | Titanium M73      | LMQ11073 | 260,- |
|                        | Aluminium M79     | LMQ11079 | 260,- |
| MATĒTS                 | Nero G40          | LGQ11040 | 260,- |
|                        | Tortora G43       | LGQ11043 | 260,- |
|                        | Cemento G48       | LGQ11048 | 260,- |
|                        | Bianco G68        | LGQ11068 | 260,- |
|                        | Espresso G78      | LGQ11078 | 260,- |
| KLASISKS               | Avena G51         | LGQ11051 | 260,- |
|                        | Antracite G59     | LGQ11059 | 260,- |
|                        | Bianco Antico G62 | LGQ11062 | 260,- |

## QUADRA 105



Dark Grey  
K89

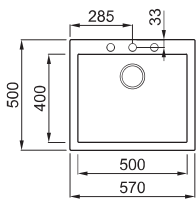

Izmērs (mm) **570 x 500**  
 Skapiša platums (mm) **600**  
 Izgriezums (mm) **550 x 480**  
 Bļodas dziļums (mm) **200**  
 Montāžas veids **legriežama**

### IETEICAMIE PIEDERUMI

|    |    |    |    |     |     |   |
|----|----|----|----|-----|-----|---|
| 91 | 97 | 25 | 50 | 152 | 163 | 4 |
| 5  | 75 | 67 | 9  | 194 | 195 |   |

### MATERIĀLS UN KRĀSAS

| KERATEK        |          | Cena € |
|----------------|----------|--------|
| Black K86      | LKQ10586 | 316,-  |
| Dove Grey K93  | LKQ10593 | 316,-  |
| Champagne K95  | LKQ10595 | 316,-  |
| White K96      | LKQ10596 | 316,-  |
| Light Grey K97 | LKQ10597 | 316,-  |
| Dark Grey K99  | LKQ10599 | 316,-  |

### GRANITEK

| GRANITEK               |          | Cena € |
|------------------------|----------|--------|
| NATURAL GRANITE EFFECT |          |        |
| METĀLISKS              |          |        |
| Nero Metal M70         | LMQ10570 | 247,-  |
| Titanium M73           | LMQ10573 | 247,-  |
| Aluminium M79          | LMQ10579 | 247,-  |
| MATĒTS                 |          |        |
| Nero G40               | LGQ10540 | 247,-  |
| Tortora G43            | LGQ10543 | 247,-  |
| Cemento G48            | LGQ10548 | 247,-  |
| Bianco G68             | LGQ10568 | 247,-  |
| Espresso G78           | LGQ10578 | 247,-  |
| KLASISKS               |          |        |
| Avena G51              | LGQ10551 | 247,-  |
| Antracite G59          | LGQ10559 | 247,-  |
| Bianco Antico G62      | LGQ10562 | 247,-  |

## QUADRA 102



Dark Grey  
K89

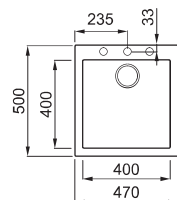

Izmērs (mm) **470 x 500**  
 Skapiša platums (mm) **450 ||| 500 ja pirmais skapis**  
 Izgriezums (mm) **450 x 480**  
 Bļodas dziļums (mm) **200**  
 Montāžas veids **legriežama**

### IETEICAMIE PIEDERUMI

|    |     |     |    |     |     |   |   |    |    |
|----|-----|-----|----|-----|-----|---|---|----|----|
| 91 | 97  | 25  | 50 | 152 | 163 | 4 | 5 | 75 | 43 |
| 9  | 194 | 195 |    |     |     |   |   |    |    |

### MATERIĀLS UN KRĀSAS

| KERATEK        |          | Cena € |
|----------------|----------|--------|
| Black K86      | LKQ10286 | 296,-  |
| Dove Grey K93  | LKQ10293 | 296,-  |
| Champagne K95  | LKQ10295 | 296,-  |
| White K96      | LKQ10296 | 296,-  |
| Light Grey K97 | LKQ10297 | 296,-  |
| Dark Grey K99  | LKQ10299 | 296,-  |

### GRANITEK

| GRANITEK               |          | Cena € |
|------------------------|----------|--------|
| NATURAL GRANITE EFFECT |          |        |
| METĀLISKS              |          |        |
| Nero Metal M70         | LMQ10270 | 235,-  |
| Titanium M73           | LMQ10273 | 235,-  |
| Aluminium M79          | LMQ10279 | 235,-  |
| MATĒTS                 |          |        |
| Nero G40               | LGQ10240 | 235,-  |
| Tortora G43            | LGQ10243 | 235,-  |
| Cemento G48            | LGQ10248 | 235,-  |
| Bianco G68             | LGQ10268 | 235,-  |
| Espresso G78           | LGQ10278 | 235,-  |
| KLASISKS               |          |        |
| Avena G51              | LGQ10251 | 235,-  |
| Antracite G59          | LGQ10259 | 235,-  |
| Bianco Antico G62      | LGQ10262 | 235,-  |

## QUADRA 100



Nero  
G40

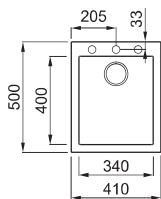

Izmērs (mm) **410 x 500**  
 Skapiša platums (mm) **450**  
 Izgriezums (mm) **390 x 480**  
 Bļodas dziļums (mm) **190**  
 Montāžas veids **iegriežama**

### IETEICAMIE PIEDERUMI

|    |    |    |    |     |     |   |
|----|----|----|----|-----|-----|---|
| 91 | 97 | 25 | 50 | 152 | 163 | 4 |
| 5  | 75 | 43 | 9  | 194 | 195 |   |

### MATERIĀLS UN KRĀSAS

| KERATEK        |          | Cena € |
|----------------|----------|--------|
| Black K86      | LKQ10086 | 259,-  |
| Dove Grey K93  | LKQ10093 | 259,-  |
| Champagne K95  | LKQ10095 | 259,-  |
| White K96      | LKQ10096 | 259,-  |
| Light Grey K97 | LKQ10097 | 259,-  |
| Dark Grey K99  | LKQ10099 | 259,-  |

### GRANITEK

| GRANITEK          |          | Cena € |
|-------------------|----------|--------|
| <b>METĀLISKS</b>  |          |        |
| Nero Metal M70    | LMQ10070 | 203,-  |
| Titanium M73      | LMQ10073 | 203,-  |
| Aluminium M79     | LMQ10079 | 203,-  |
| <b>MATĒTS</b>     |          |        |
| Nero G40          | LGQ10040 | 203,-  |
| Tortora G43       | LGQ10043 | 203,-  |
| Cemento G48       | LGQ10048 | 203,-  |
| Bianco G68        | LGQ10068 | 203,-  |
| Espresso G78      | LGQ10078 | 203,-  |
| <b>KLASISKS</b>   |          |        |
| Avena G51         | LGQ10051 | 203,-  |
| Antracite G59     | LGQ10059 | 203,-  |
| Bianco Antico G62 | LGQ10062 | 203,-  |

## QUADRA 50



Nero  
G40

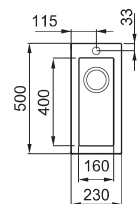

Izmērs (mm) **230 x 500**  
 Skapiša platums (mm) **300**  
 Izgriezums (mm) **Pēc šablona**  
 Bļodas dziļums (mm) **155**  
 Montāžas veids **iegriežama**  
 Installation **12345**  
 Position

### IETEICAMIE PIEDERUMI

|     |   |
|-----|---|
| 163 | 9 |
|-----|---|

### MATERIĀLS UN KRĀSAS

| KERATEK        |          | Cena € |
|----------------|----------|--------|
| Black K86      | LKQ05086 | 247,-  |
| Dove Grey K93  | LKQ05093 | 247,-  |
| Champagne K95  | LKQ05095 | 247,-  |
| White K96      | LKQ05096 | 247,-  |
| Light Grey K97 | LKQ05097 | 247,-  |
| Dark Grey K99  | LKQ05099 | 247,-  |

### GRANITEK

| GRANITEK          |          | Cena € |
|-------------------|----------|--------|
| <b>METĀLISKS</b>  |          |        |
| Nero Metal M70    | LMQ05070 | 185,-  |
| Titanium M73      | LMQ05073 | 185,-  |
| Aluminium M79     | LMQ05079 | 185,-  |
| <b>MATĒTS</b>     |          |        |
| Nero G40          | LGQ05040 | 185,-  |
| Tortora G43       | LGQ05043 | 185,-  |
| Cemento G48       | LGQ05048 | 185,-  |
| Bianco G68        | LGQ05068 | 185,-  |
| Espresso G78      | LGQ05078 | 185,-  |
| <b>KLASISKS</b>   |          |        |
| Avena G51         | LGQ05051 | 185,-  |
| Antracite G59     | LGQ05059 | 185,-  |
| Bianco Antico G62 | LGQ05062 | 185,-  |

## QUADRA 350



Bianco  
G68

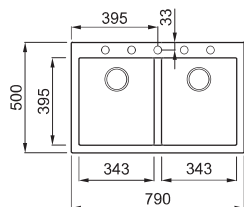

Izmērs (mm) **790 x 500**  
 Skapiša platums (mm) **800**  
 Izgriezums (mm) **770 x 480**  
 Bļodas dziļums (mm) **210**  
 Montāžas veids **iegriežama 01\***

### IETEICAMIE PIEDERUMI

|    |    |    |    |     |     |     |
|----|----|----|----|-----|-----|-----|
| 91 | 96 | 25 | 50 | 152 | 157 | 163 |
| 4  | 5  | 75 | 43 | 9   |     |     |

### MATERIĀLS UN KRĀSAS

| KERATEK        |          | Cena € |
|----------------|----------|--------|
| Black K86      | LKQ35086 | 396,-  |
| Dove Grey K93  | LKQ35093 | 396,-  |
| Champagne K95  | LKQ35095 | 396,-  |
| White K96      | LKQ35096 | 396,-  |
| Light Grey K97 | LKQ35097 | 396,-  |
| Dark Grey K99  | LKQ35099 | 396,-  |

### GRANITEK

| GRANITEK          |          | Cena € |
|-------------------|----------|--------|
| <b>METĀLISKS</b>  |          |        |
| Nero Metal M70    | LMQ35070 | 298,-  |
| Titanium M73      | LMQ35073 | 298,-  |
| Aluminium M79     | LMQ35079 | 298,-  |
| <b>MATĒTS</b>     |          |        |
| Nero G40          | LGQ35040 | 298,-  |
| Tortora G43       | LGQ35043 | 298,-  |
| Cemento G48       | LGQ35048 | 298,-  |
| Bianco G68        | LGQ35068 | 298,-  |
| Espresso G78      | LGQ35078 | 298,-  |
| <b>KLASISKS</b>   |          |        |
| Avena G51         | LGQ35051 | 298,-  |
| Antracite G59     | LGQ35059 | 298,-  |
| Bianco Antico G62 | LGQ35062 | 298,-  |

## QUADRA 340



Bianco  
G68

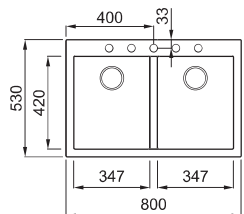

Izmērs (mm) **800 x 530**  
 Skapiša platums (mm) **800 ||| 900 ja pirmais skapis**  
 Izgriezums (mm) **780 x 510**  
 Bļodas dziļums (mm) **215**  
 Montāžas veids **iegriežama**

### IETEICAMIE PIEDERUMI

|    |    |    |     |     |   |    |
|----|----|----|-----|-----|---|----|
| 96 | 25 | 50 | 156 | 163 | 5 | 75 |
| 43 | 9  |    |     |     |   |    |

### MATERIĀLS UN KRĀSAS

| GRANITEK         |             | Cena € |
|------------------|-------------|--------|
| <b>METĀLISKS</b> |             |        |
| Titanium M73     | LMQ34073BTP | 322,-  |
| Aluminium M79    | LMQ34079BTP | 322,-  |
| <b>MATĒTS</b>    |             |        |
| Nero G40         | LGQ34040BTP | 322,-  |
| Tortora G43      | LGQ34043BTP | 322,-  |
| Bianco G68       | LGQ34068BTP | 322,-  |
| <b>KLASISKS</b>  |             |        |
| Avena G51        | LGQ34051BTP | 322,-  |

## QUADRA 440



Titanium  
M73

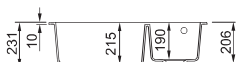
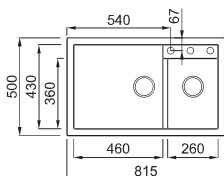

Izmērs (mm) **815 x 500**  
 Skapiša platums (mm) **800 ||| 900 ja pirmais skapis**  
 Izgriezums (mm) **800 x 480**  
 Bļodas 1 dziļums (mm) **215**  
 Bļodas 2 dziļums (mm) **190**  
 Montāžas veids **legriežama**

### IETEICAMIE PIEDERUMI

|    |    |    |     |     |   |   |
|----|----|----|-----|-----|---|---|
| 96 | 25 | 50 | 156 | 163 | 4 | 5 |
| 75 | 43 | 9  |     |     |   |   |

### MATERIĀLS UN KRĀSAS

|           | GRANITEK<br>NATURAL GRANITE EFFECT |          | Cena € |
|-----------|------------------------------------|----------|--------|
| METĀLISKS | Titanium M73                       | LMQ44073 | 334,-  |
|           | Aluminium M79                      | LMQ44079 | 334,-  |
|           |                                    |          |        |
| MATĒTS    | Nero G40                           | LGQ44040 | 334,-  |
|           | Tortora G43                        | LGQ44043 | 334,-  |
|           | Bianco G68                         | LGQ44068 | 334,-  |
| KLASISKS  | Avena G51                          | LGQ44051 | 334,-  |

## QUADRA 150



Titanium  
M73

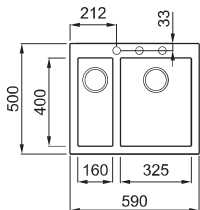

Izmērs (mm) **590 x 500**  
 Skapiša platums (mm) **600**  
 Izgriezums (mm) **570 x 480**  
 Bļodas 1 dziļums (mm) **200**  
 Bļodas 2 dziļums (mm) **155**  
 Montāžas veids **legriežama**

### IETEICAMIE PIEDERUMI

|    |    |    |    |     |     |     |
|----|----|----|----|-----|-----|-----|
| 91 | 96 | 25 | 50 | 152 | 157 | 163 |
| 4  | 5  | 75 | 43 | 9   |     |     |

### MATERIĀLS UN KRĀSAS

|           | KERATEK<br>CHINA WHITE TECHNOLOGY |          | Cena € |  |
|-----------|-----------------------------------|----------|--------|--|
| METĀLISKS | Black K86                         | LKQ15086 | 346,-  |  |
|           | Dove Grey K93                     | LKQ15093 | 346,-  |  |
|           | Champagne K95                     | LKQ15095 | 346,-  |  |
|           | White K96                         | LKQ15096 | 346,-  |  |
|           | Light Grey K97                    | LKQ15097 | 346,-  |  |
|           | Dark Grey K99                     | LKQ15099 | 346,-  |  |
|           |                                   |          |        |  |
|           |                                   |          |        |  |
|           |                                   |          |        |  |
| MATĒTS    | Nero Metal M70                    | LMQ15070 | 274,-  |  |
|           | Titanium M73                      | LMQ15073 | 274,-  |  |
|           | Aluminium M79                     | LMQ15079 | 274,-  |  |
|           |                                   |          |        |  |
|           | Nero G40                          | LGQ15040 | 274,-  |  |
|           | Tortora G43                       | LGQ15043 | 274,-  |  |
|           | Cemento G48                       | LGQ15048 | 274,-  |  |
|           | Bianco G68                        | LGQ15068 | 274,-  |  |
|           | Espresso G78                      | LGQ15078 | 274,-  |  |
| KLASISKS  | Avena G51                         | LGQ15051 | 274,-  |  |
|           | Antracite G59                     | LGQ15059 | 274,-  |  |
|           | Bianco Antico G62                 | LGQ15062 | 274,-  |  |



elleci | VIRTUVE

QUADRA



Nero  
G40

MATERIĀLS UN KRĀSAS

**KERATEK**  
SEMĀRĀS VIRTUVES IZLIETNES

- Black K86
- Dove Grey K93
- Champagne K95
- White K96
- Light Grey K97
- Dark Grey K99

**GRANITEK**  
NATURAL GRANITE EFFECT

METĀLISKS

- Nero Metal M70
- Titanium M73
- Aluminium M79

MATĒTS

- Nero G40
- Tortora G43
- Cemento G48
- Bianco G68
- Espresso G78

KLASISKS

- Avena G51
- Antracite G59
- Bianco Antico G62

IETEICAMIE PIEDERUMI

|    |    |    |    |     |     |     |
|----|----|----|----|-----|-----|-----|
| 91 | 97 | 25 | 50 | 152 | 157 | 163 |
| 4  | 5  | 75 | 43 | 9   |     |     |



Izlietne Quadra 130 Titanium M73 | Maisītājs Tema Black K86

KOLEKCIJA

# QUADRA PABŪVĒJAMĀS izlietnes

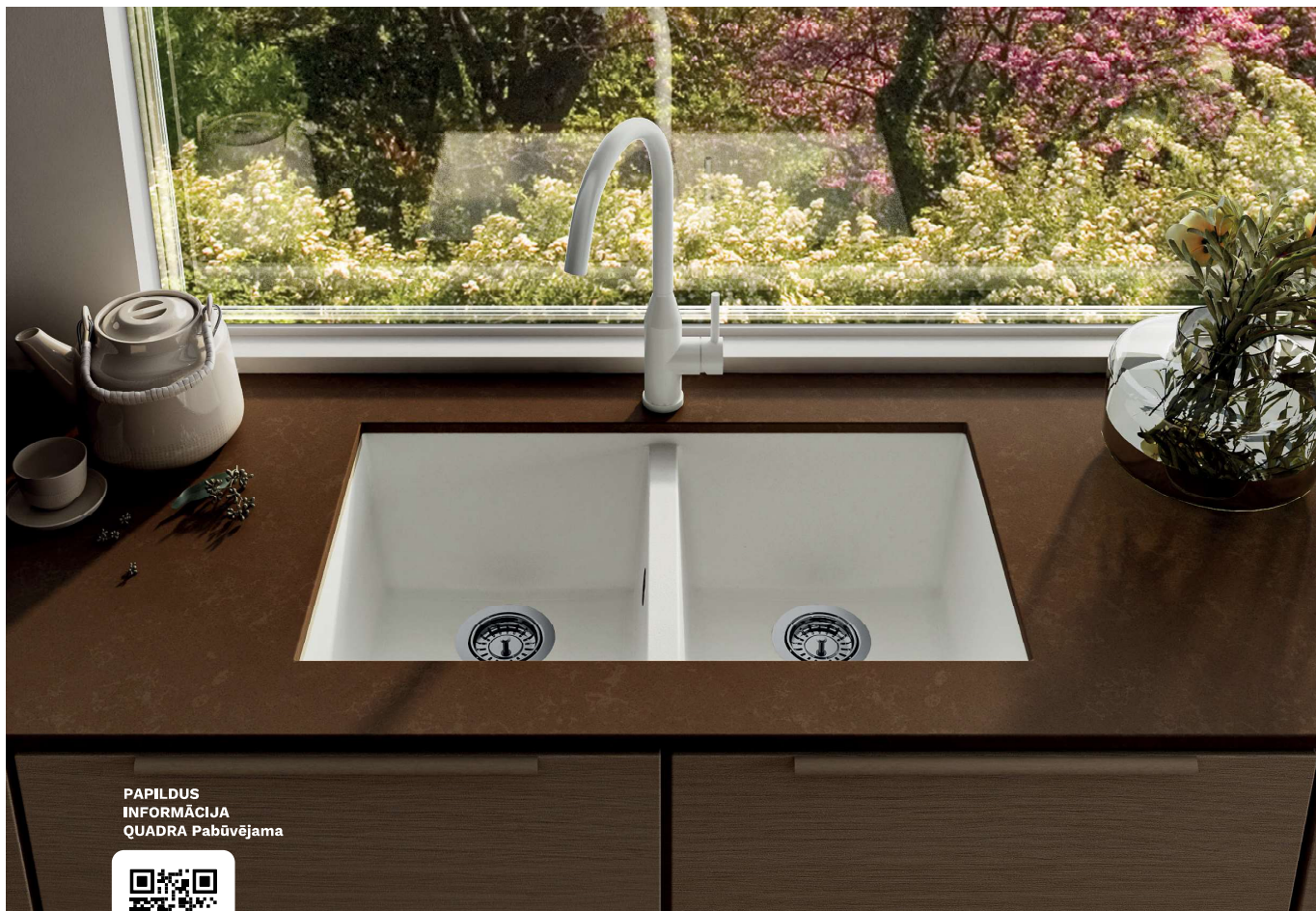

PAPILDUS  
INFORMĀCIJA  
QUADRA Pabūvējama



## KAD RADOŠUMS TIEK PĀRVĒRSTS FUNKCIONALITĀTĒ

Šī kolekcija ir izstrādāta tā, lai optimizētu izlietnes iebūvētos aspektus un nodrošinātu darba virsmas vieglu un ērtu tīrīšanu.

## PLUS QUADRA PABŪVĒJAMA



ELEMENT  
PIEDERUMI



MAISĪTĀJS  
MONTEJAS  
UZ VIRSMAS

## GRANITEK®

NATURAL GRANITE EFFECT

● Nero Metal  
M70

● Titanium  
M73

● Aluminium  
M79

● Nero  
G40

● Tortora  
G43

● Cemento  
G48

● Bianco  
G68

● Espresso  
G78

● Avena  
G51

● Antracite  
G59

● Bianco Antico  
G62

## KERATEK®

CERAMIC NANOTECHNOLOGY CN6

● Black  
K86

● Dove Grey  
K93

● Champagne  
K95

● White  
K96

● Light Grey  
K97

● Dark Grey  
K99

## MODELIS QUADRA PABŪVĒJAMA

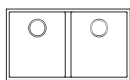

QUADRA 350



QUADRA 150

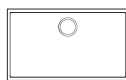

QUADRA 130



QUADRA 110



QUADRA 105



QUADRA 102



QUADRA 100



QUADRA 50

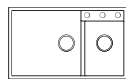

QUADRA 440

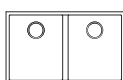

QUADRA 340

**Komplektā:** Vietu taupošs sifons, ventiļu sistēma ar apaļu pārplūdi un montāžas āķi.

## IETEICAMIE PIEDERUMI

157

**LOKANĀIS PAKLĀJS  
FLEX 440 ELEMENT**  
ARS013BK  
110. Lpp.

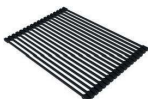

Apdare



Melns

152

**CAURDURIS  
418 ELEMENT**  
AVP035BK  
111. Lpp.



Apdare



Melns

75

**GROZS**

ACI01307  
117. Lpp.



68

**IZLIETNES PAMATNES  
METĀLA REŽĢIS**  
AGB01303  
116. Lpp.

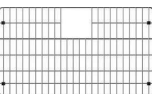

\*Lai iegūtu plašāku informāciju, skatiet piederumu sadaļu 106. lappusē

## PERFEKTI SADERĪGS ŪDENS MAISĪTĀJS



**ADIGE – Nerūsējošais tērauds IN**  
MIKADIIN

128. Lpp.

Pieejamās krāsas



Nerūsējošais  
tērauds  
IN



Nero  
G40



Bianco  
G68



Black  
K86



White  
K96

## PAPILDUS



ELEMENT KOMPLEKTS  
**ZIEPJU DOZATORS ELEMENT**  
Art. ADI02300

111. Lpp.

## elleci | BEAUTY



Produktu linija, kas īpaši izstrādāta kompozitmateriālu izlietņu kopšanai.

Vairāk informācijas 140.lpp.

## QUADRA 130 PABŪVĒJAMA



White  
K96

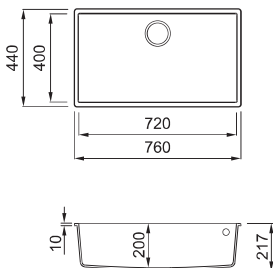

Izmērs (mm) **760 x 440**  
 Skapiša platums (mm) **800**  
 Izgriezums (mm) **720 x 400 R5**  
 Bļodas dziļums (mm) **200**  
 Montāžas veids **Pabūvējama**

### IETEICAMIE PIEDERUMI

152 157 163 75 68 9 194

### MATERIĀLS UN KRĀSAS

|   |             | Cena € |
|---|-------------|--------|
| <b>KERATEK</b><br><small>LOWE GROUP COMPANY</small> |             |        |
| Black K86   | LKQ13086BSO | 358,-  |
| Dove Grey K93                                       | LKQ13093BSO | 358,-  |
| Champagne K95                                       | LKQ13095BSO | 358,-  |
| White K96   | LKQ13096BSO | 358,-  |
| Light Grey K97                                      | LKQ13097BSO | 358,-  |
| Dark Grey K99                                       | LKQ13099BSO | 358,-  |

### GRANITEK

NATURAL GRANITE EFFECT

| METĀLISKS | Nero Metal M70    | LMQ13070BSO 296,- |
|-----------|-------------------|-------------------|
|           | Titanium M73      | LMQ13073BSO 296,- |
|           | Aluminium M79     | LMQ13079BSO 296,- |
| MATĒTS    | Nero G40          | LGQ13040BSO 296,- |
|           | Tortora G43       | LGQ13043BSO 296,- |
|           | Cemento G48       | LGQ13048BSO 296,- |
|           | Bianco G68        | LGQ13068BSO 296,- |
|           | Espresso G78      | LGQ13078BSO 296,- |
| KLASISKS  | Avena G51         | LGQ13051BSO 296,- |
|           | Antracite G59     | LGQ13059BSO 296,- |
|           | Bianco Antico G62 | LGQ13062BSO 296,- |

## QUADRA 110 PABŪVĒJAMA



White  
K96

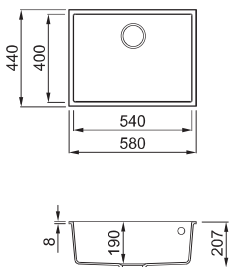

Izmērs (mm) **580 x 440**  
 Skapiša platums (mm) **800**  
 Izgriezums (mm) **540 x 400 R5**  
 Bļodas dziļums (mm) **190**  
 Montāžas veids **Pabūvējama**

### IETEICAMIE PIEDERUMI

152 157 163 75 67 9 194

### MATERIĀLS UN KRĀSAS

|   |             | Cena € |
|---|-------------|--------|
| <b>KERATEK</b><br><small>LOWE GROUP COMPANY</small> |             |        |
| Black K86   | LKQ11086BSO | 326,-  |
| Dove Grey K93                                       | LKQ11093BSO | 326,-  |
| Champagne K95                                       | LKQ11095BSO | 326,-  |
| White K96   | LKQ11096BSO | 326,-  |
| Light Grey K97                                      | LKQ11097BSO | 326,-  |
| Dark Grey K99                                       | LKQ11099BSO | 326,-  |

### GRANITEK

NATURAL GRANITE EFFECT

| METĀLISKS | Nero Metal M70    | LMQ11070BSO 264,- |
|-----------|-------------------|-------------------|
|           | Titanium M73      | LMQ11073BSO 264,- |
|           | Aluminium M79     | LMQ11079BSO 264,- |
| MATĒTS    | Nero G40          | LGQ11040BSO 264,- |
|           | Tortora G43       | LGQ11043BSO 264,- |
|           | Cemento G48       | LGQ11048BSO 264,- |
|           | Bianco G68        | LGQ11068BSO 264,- |
|           | Espresso G78      | LGQ11078BSO 264,- |
| KLASISKS  | Avena G51         | LGQ11051BSO 264,- |
|           | Antracite G59     | LGQ11059BSO 264,- |
|           | Bianco Antico G62 | LGQ11062BSO 264,- |

## QUADRA 105 PABŪVĒJAMA



Tortora  
G43

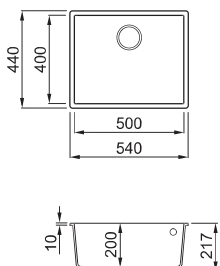

Izmērs (mm) **540 x 440**  
Skapiša platums (mm) **600**  
Izgriezums (mm) **500 x 400 R5**  
Blodas dziļums (mm) **200**  
Montāžas veids **Pabūvējama**

### IETEICAMIE PIEDERUMI

152 163 75 43 9 194

### MATERIĀLS UN KRĀSAS

| KERATEK        |             | Cena € |
|----------------|-------------|--------|
| Black K86      | LKQ10586BSO | 322,-  |
| Dove Grey K93  | LKQ10593BSO | 322,-  |
| Champagne K95  | LKQ10595BSO | 322,-  |
| White K96      | LKQ10596BSO | 322,-  |
| Light Grey K97 | LKQ10597BSO | 322,-  |
| Dark Grey K99  | LKQ10599BSO | 322,-  |

### GRANITEK

| GRANITEK               |                   | Cena €            |
|------------------------|-------------------|-------------------|
| NATURAL GRANITE EFFECT |                   |                   |
| METĀLISKS              | Nero Metal M70    | LMQ10570BSO 266,- |
|                        | Titanium M73      | LMQ10573BSO 266,- |
|                        | Aluminium M79     | LMQ10579BSO 266,- |
| MATĒTS                 | Nero G40          | LGQ10540BSO 266,- |
|                        | Tortora G43       | LGQ10543BSO 266,- |
|                        | Cemento G48       | LGQ10548BSO 266,- |
|                        | Bianco G68        | LGQ10568BSO 266,- |
|                        | Espresso G78      | LGQ10578BSO 266,- |
| KLASISKS               | Avena G51         | LGQ10551BSO 266,- |
|                        | Antracite G59     | LGQ10559BSO 266,- |
|                        | Bianco Antico G62 | LGQ10562BSO 266,- |

## QUADRA 102 PABŪVĒJAMA



Tortora  
G43

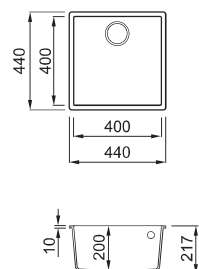

Izmērs (mm) **440 x 440**  
Skapiša platums (mm) **500**  
Izgriezums (mm) **400 x 400 R5**  
Blodas dziļums (mm) **200**  
Montāžas veids **Pabūvējama**

### IETEICAMIE PIEDERUMI

152 163 75 43 9 194

### MATERIĀLS UN KRĀSAS

| KERATEK        |             | Cena € |
|----------------|-------------|--------|
| Black K86      | LKQ10286BSO | 310,-  |
| Dove Grey K93  | LKQ10293BSO | 310,-  |
| Champagne K95  | LKQ10295BSO | 310,-  |
| White K96      | LKQ10296BSO | 310,-  |
| Light Grey K97 | LKQ10297BSO | 310,-  |
| Dark Grey K99  | LKQ10299BSO | 310,-  |

### GRANITEK

| GRANITEK               |                   | Cena €            |
|------------------------|-------------------|-------------------|
| NATURAL GRANITE EFFECT |                   |                   |
| METĀLISKS              | Nero Metal M70    | LMQ10270BSO 247,- |
|                        | Titanium M73      | LMQ10273BSO 247,- |
|                        | Aluminium M79     | LMQ10279BSO 247,- |
| MATĒTS                 | Nero G40          | LGQ10240BSO 247,- |
|                        | Tortora G43       | LGQ10243BSO 247,- |
|                        | Cemento G48       | LGQ10248BSO 247,- |
|                        | Bianco G68        | LGQ10268BSO 247,- |
|                        | Espresso G78      | LGQ10278BSO 247,- |
| KLASISKS               | Avena G51         | LGQ10251BSO 247,- |
|                        | Antracite G59     | LGQ10259BSO 247,- |
|                        | Bianco Antico G62 | LGQ10262BSO 247,- |

## QUADRA 100 PABŪVĒJAMA



Bianco  
G68

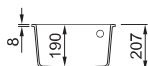
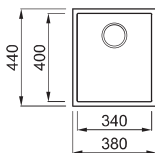

Izmērs (mm) **380 x 440**  
 Skapiša platums (mm) **450**  
 Izgriezums (mm) **340 x 400 R5**  
 Bļodas dziļums (mm) **190**  
 Montāžas veids **Pabūvējama**

### IETEICAMIE PIEDERUMI

152 163 75 43 9 194

### MATERIĀLS UN KRĀSAS

| KERATEK        |             | Cena € |
|----------------|-------------|--------|
| Black K86      | LKQ10086BSO | 272,-  |
| Dove Grey K93  | LKQ10093BSO | 272,-  |
| Champagne K95  | LKQ10095BSO | 272,-  |
| White K96      | LKQ10096BSO | 272,-  |
| Light Grey K97 | LKQ10097BSO | 272,-  |
| Dark Grey K99  | LKQ10099BSO | 272,-  |

### GRANITEK

| GRANITEK               |             | Cena € |
|------------------------|-------------|--------|
| NATURAL GRANITE EFFECT |             |        |
| METĀLISKS              |             |        |
| Nero Metal M70         | LMQ10070BSO | 219,-  |
| Titanium M73           | LMQ10073BSO | 219,-  |
| Aluminium M79          | LMQ10079BSO | 219,-  |
| MATĒTS                 |             |        |
| Nero G40               | LGQ10040BSO | 219,-  |
| Tortora G43            | LGQ10043BSO | 219,-  |
| Cemento G48            | LGQ10048BSO | 219,-  |
| Bianco G68             | LGQ10068BSO | 219,-  |
| Espresso G78           | LGQ10078BSO | 219,-  |
| KLASISKS               |             |        |
| Avena G51              | LGQ10051BSO | 219,-  |
| Antracite G59          | LGQ10059BSO | 219,-  |
| Bianco Antico G62      | LGQ10062BSO | 219,-  |

## QUADRA 50 PABŪVĒJAMA



Bianco  
G68

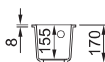
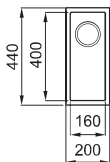

Izmērs (mm) **200 x 440**  
 Skapiša platums (mm) **300**  
 Izgriezums (mm) **160 x 400 R5**  
 Bļodas dziļums (mm) **155**  
 Montāžas veids **Pabūvējama**

### IETEICAMIE PIEDERUMI

163 9 194

### MATERIĀLS UN KRĀSAS

| KERATEK        |             | Cena € |
|----------------|-------------|--------|
| Black K86      | LKQ05086BSO | 247,-  |
| Dove Grey K93  | LKQ05093BSO | 247,-  |
| Champagne K95  | LKQ05095BSO | 247,-  |
| White K96      | LKQ05096BSO | 247,-  |
| Light Grey K97 | LKQ05097BSO | 247,-  |
| Dark Grey K99  | LKQ05099BSO | 247,-  |

### GRANITEK

| GRANITEK               |             | Cena € |
|------------------------|-------------|--------|
| NATURAL GRANITE EFFECT |             |        |
| METĀLISKS              |             |        |
| Nero Metal M70         | LMQ05070BSO | 187,-  |
| Titanium M73           | LMQ05073BSO | 187,-  |
| Aluminium M79          | LMQ05079BSO | 187,-  |
| MATĒTS                 |             |        |
| Nero G40               | LGQ05040BSO | 187,-  |
| Tortora G43            | LGQ05043BSO | 187,-  |
| Cemento G48            | LGQ05048BSO | 187,-  |
| Bianco G68             | LGQ05068BSO | 187,-  |
| Espresso G78           | LGQ05078BSO | 187,-  |
| KLASISKS               |             |        |
| Avena G51              | LGQ05051BSO | 187,-  |
| Antracite G59          | LGQ05059BSO | 187,-  |
| Bianco Antico G62      | LGQ05062BSO | 187,-  |

## QUADRA 350 PABŪVEJAMA



Tortora  
G43

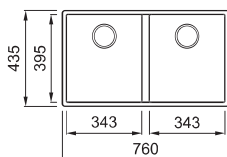

Izmērs (mm) **760 x 435**  
 Skapiša platums (mm) **800**  
 Izgriezums (mm) **720 x 395 R5**  
 Bļodas dziļums (mm) **220**  
 Montāžas veids **Pabūvējama**

### IETEICAMIE PIEDERUMI

152 157 163 5 75 43 9

### MATERIĀLS UN KRĀSAS

| KERATEK        |             | Cena € |
|----------------|-------------|--------|
| Black K86      | LKQ35086BSO | 408,-  |
| Dove Grey K93  | LKQ35093BSO | 408,-  |
| Champagne K95  | LKQ35095BSO | 408,-  |
| White K96      | LKQ35096BSO | 408,-  |
| Light Grey K97 | LKQ35097BSO | 408,-  |
| Dark Grey K99  | LKQ35099BSO | 408,-  |

### GRANITEK

| GRANITEK          |             | Cena € |
|-------------------|-------------|--------|
| <b>METĀLISKS</b>  |             |        |
| Nero Metal M70    | LMQ35070BSO | 319,-  |
| Titanium M73      | LMQ35073BSO | 319,-  |
| Aluminium M79     | LMQ35079BSO | 319,-  |
| <b>MATĒTS</b>     |             |        |
| Nero G40          | LGQ35040BSO | 319,-  |
| Tortora G43       | LGQ35043BSO | 319,-  |
| Cemento G48       | LGQ35048BSO | 319,-  |
| Bianco G68        | LGQ35068BSO | 319,-  |
| Espresso G78      | LGQ35078BSO | 319,-  |
| <b>KLASISKS</b>   |             |        |
| Avena G51         | LGQ35051BSO | 319,-  |
| Antracite G59     | LGQ35059BSO | 319,-  |
| Bianco Antico G62 | LGQ35062BSO | 319,-  |

## QUADRA 340 PABŪVEJAMA



Tortora  
G43

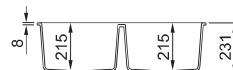
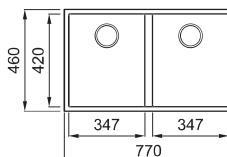

Izmērs (mm) **770 x 460**  
 Skapiša platums (mm) **900**  
 Izgriezums (mm) **730 x 420 R5**  
 Bļodas dziļums (mm) **215**  
 Montāžas veids **Pabūvējama**

### IETEICAMIE PIEDERUMI

156 163 5 75 43 9

### MATERIĀLS UN KRĀSAS

| GRANITEK         |             | Cena € |
|------------------|-------------|--------|
| <b>METĀLISKS</b> |             |        |
| Titanium M73     | LMQ34073BSC | 346,-  |
| Aluminium M79    | LMQ34079BSC | 346,-  |
| <b>MATĒTS</b>    |             |        |
| Nero G40         | LGQ34040BSC | 346,-  |
| Tortora G43      | LGQ34043BSC | 346,-  |
| Bianco G68       | LGQ34068BSC | 346,-  |
| <b>KLASISKS</b>  |             |        |
| Avena G51        | LGQ34051BSC | 346,-  |

## QUADRA 440 PABŪVĒJAMA



Bianco  
G68

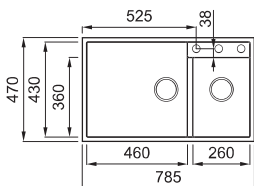

Izmērs (mm) **785 x 470**  
 Skapiša platums (mm) **900**  
 Izgriezums (mm) **745 x 430 R5**  
 Bļodas 1 dziļums (mm) **215**  
 Bļodas 2 dziļums (mm) **190**  
 Montāžas veids **Pabūvējama**



### IETEICAMIE PIEDERUMI

96 25 50 156 163 75 43 9

### MATERIĀLS UN KRĀSAS

| MATERIĀLS | KRĀSA                                     | Modelis     | Cena € |
|-----------|---|-------------|--------|
| METĀLISKS | <b>GRANITEK</b><br>NATURAL GRANITE EFFECT |             |        |
|           | Titanium M73                              | LMQ44073BSO | 358,-  |
|           | Aluminium M79                             | LMQ44079BSO | 358,-  |
| MATĒTS    | Nero G40                                  | LGQ44040BSO | 358,-  |
|           | Tortora G43                               | LGQ44043BSO | 358,-  |
|           | Bianco G68                                | LGQ44068BSO | 358,-  |
| KLASISKS  | Avena G51                                 | LGQ44051BSO | 358,-  |

## QUADRA 150 PABŪVĒJAMA



Bianco  
G68

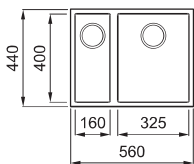

Izmērs (mm) **560 x 440**  
 Skapiša platums (mm) **600**  
 Izgriezums (mm) **520 x 400 R5**  
 Bļodas 1 dziļums (mm) **200**  
 Bļodas 2 dziļums (mm) **155**  
 Montāžas veids **Pabūvējama**



### IETEICAMIE PIEDERUMI

152 157 163 5 75 143 9

### MATERIĀLS UN KRĀSAS

| MATERIĀLS     | KRĀSA                                     | Modelis     | Cena € |
|---------------|---|-------------|--------|
| METĀLISKS     | <b>KERATEK</b><br>GROUP POLSKA TECHNOLOGY |             |        |
|               | Black K86                                 | LKQ15086BSO | 358,-  |
|               | Dove Grey K93                             | LKQ15093BSO | 358,-  |
|               | Champagne K95                             | LKQ15095BSO | 358,-  |
|               | White K96                                 | LKQ15096BSO | 358,-  |
|               | Light Grey K97                            | LKQ15097BSO | 358,-  |
|               | Dark Grey K99                             | LKQ15099BSO | 358,-  |
|               | Nero Metal M70                            | LMQ15070BSO | 287,-  |
|               | Titanium M73                              | LMQ15073BSO | 287,-  |
| Aluminium M79 | LMQ15079BSO                               | 287,-       |        |
| MATĒTS        | Nero G40                                  | LGQ15040BSO | 287,-  |
|               | Tortora G43                               | LGQ15043BSO | 287,-  |
|               | Cemento G48                               | LGQ15048BSO | 287,-  |
|               | Bianco G68                                | LGQ15068BSO | 287,-  |
|               | Espresso G78                              | LGQ15078BSO | 287,-  |
|               | Avena G51                                 | LGQ15051BSO | 287,-  |
|               | Antracite G59                             | LGQ15059BSO | 287,-  |
| KLASISKS      | Bianco Antico G62                         | LGQ15062BSO | 287,-  |



Izlietne Quadra 130 pabūvējama | FLOW-PRO black ventilis

KOLEKCIJA  
**BEST**



PAPILDUS  
INFORMĀCIJA  
BEST



**AR RACIONĀLĀM UN ĢEOMETRISKĀM LĪNIJĀM**

Best ir kompozītmateriāla izlietņu kolekcija ar racionālu estētiku, kas nodrošina maksimālu efektivitāti, pateicoties profesionālai aizsargmalai un piederumiem, kas slid gar izlietni. BEST izlietnēm, pilnīgākai lietošanai, ir plašāks izlietnes bļodas sadalītājs ar integrētu krāna zonu.

PLUS **BEST**



ELEMENT  
PIEDERUMI



AIZSARGMĀLA



PLAŠĀKS  
SADALĪTĀJS



FLOW-PRO

**GRANITEK**  
NATURAL GRANITE EFFECT

● Titanium  
M73

● Aluminium  
M79

● Nero  
G40

● Tortora  
G43

● Cemento  
G48

● Bianco  
G68

● Espresso  
G78

● Avena  
G51

● Antracite  
G59

● Bianco Antico  
G62

**KERATEK**  
CERAMIC NANOTECHNOLOGY CN6

● Black  
K86

● Dove Grey  
K93

● Champagne  
K95

● White  
K96

● Light Grey  
K97

● Dark Grey  
K99

## MODELIS BEST

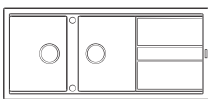

BEST 500

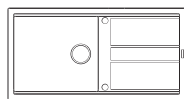

BEST 480

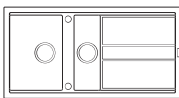

BEST 475

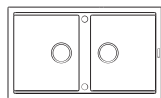

BEST 450

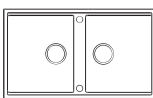

BEST 450  
PABŪVĒJAMA

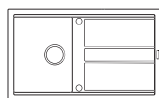

BEST 400

**Komplektā:** Vietu taupošs sifons, integrēta Flow-Pro noplūde, taisnstūrveida pārplūde un montāžas āķi.

## IETEICAMIE PIEDERUMI

89

**GRIEŽAMĀIS DĒLIS  
DĒLIS  
ELEMENT  
ATH020OL**  
108. Lpp.



**Apdare**



Melns Pelēks Ozols Goba

156

**LOKANAIS PAKLĀJS  
FLEX 500 ELEMENT  
ARS023BK**  
110. Lpp.



**Apdare**



Melns

5

**CAURDURIS**

AVI03000  
116. Lpp.



97

**SPIEDPOGA  
ELEMENT  
ASP13002BK**  
113. Lpp.



**Apdare**



Hromēts Melns

\*Lai iegūtu plašāku informāciju, skatiet piederumu sadaļu 106.lappusē

## PERFEKTI SADERĪGS ŪDENS MAISĪTĀJS



**STREAM PLUS – Nero G40**  
MGKSTP40

124. Lpp.

Pieejamās krāsas



## PAPILDUS

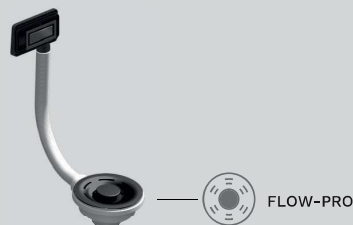

ELEMENT KOMPLEKTS  
**MELNS FLOW-PRO + PĀRPLŪDE**  
Art. KITWPT-F-1VSL-L-BK

142. Lpp.

## elleci | BEAUTY



Produktu līnija, kas īpaši izstrādāta kompozitmateriālu izlietņu kopšanai.

Vairāk informācijas 140.lpp.

## BEST 500



Dark Grey  
K99

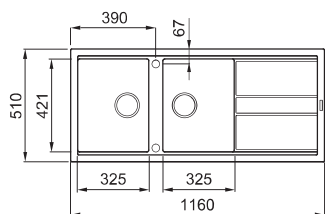

Izmērs (mm) **1160 x 510**  
Skapiša platums (mm) **800**  
Izgriezums (mm) **1140 x 480**  
Bļodas dziļums (mm) **200**  
Montāžas veids **iegriežama**

### IETEICAMIE PIEDERUMI

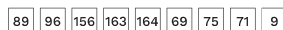

### MATERIĀLS UN KRĀSAS

| KERATEK        |          | Cena € |
|----------------|----------|--------|
| Black K86      | LKB50086 | 520,-  |
| Dove Grey K93  | LKB50093 | 520,-  |
| Champagne K95  | LKB50095 | 520,-  |
| White K96      | LKB50096 | 520,-  |
| Light Grey K97 | LKB50097 | 520,-  |
| Dark Grey K99  | LKB50099 | 520,-  |

| GRANITEK      |          | Cena € |
|---------------|----------|--------|
| Titanium M73  | LMB50073 | 371,-  |
| Aluminium M79 | LMB50079 | 371,-  |

| MATĒTS       |          | Cena € |
|--------------|----------|--------|
| Nero G40     | LGB50040 | 371,-  |
| Tortora G43  | LGB50043 | 371,-  |
| Cemento G48  | LGB50048 | 371,-  |
| Bianco G68   | LGB50068 | 371,-  |
| Espresso G78 | LGB50078 | 371,-  |

| KLASISKS          |          | Cena € |
|-------------------|----------|--------|
| Avena G51         | LGB50051 | 371,-  |
| Antracite G59     | LGB50059 | 371,-  |
| Bianco Antico G62 | LGB50062 | 371,-  |

## Aluminium

## BEST 480



Dark Grey  
K99

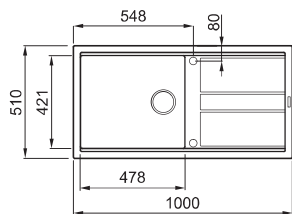

Izmērs (mm) **1000 x 510**  
Skapiša platums (mm) **600**  
Izgriezums (mm) **980 x 480**  
Bļodas dziļums (mm) **200**  
Montāžas veids **iegriežama**

### IETEICAMIE PIEDERUMI

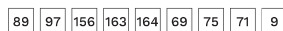

### MATERIĀLS UN KRĀSAS

| KERATEK        |          | Cena € |
|----------------|----------|--------|
| Black K86      | LKB48086 | 495,-  |
| Dove Grey K93  | LKB48093 | 495,-  |
| Champagne K95  | LKB48095 | 495,-  |
| White K96      | LKB48096 | 495,-  |
| Light Grey K97 | LKB48097 | 495,-  |
| Dark Grey K99  | LKB48099 | 495,-  |

| GRANITEK      |          | Cena € |
|---------------|----------|--------|
| Titanium M73  | LMB48073 | 346,-  |
| Aluminium M79 | LMB48079 | 346,-  |

| MATĒTS       |          | Cena € |
|--------------|----------|--------|
| Nero G40     | LGB48040 | 346,-  |
| Tortora G43  | LGB48043 | 346,-  |
| Cemento G48  | LGB48048 | 346,-  |
| Bianco G68   | LGB48068 | 346,-  |
| Espresso G78 | LGB48078 | 346,-  |

| KLASISKS          |          | Cena € |
|-------------------|----------|--------|
| Avena G51         | LGB48051 | 346,-  |
| Antracite G59     | LGB48059 | 346,-  |
| Bianco Antico G62 | LGB48062 | 346,-  |

BEST 475



White  
K96

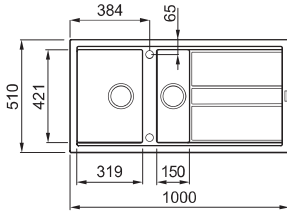

Izmērs (mm) **1000 x 510**  
 Skapīša platums (mm) **600**  
 Izgriezums (mm) **980 x 480**  
 Bļodas 1 dziļums (mm) **200**  
 Bļodas 2 dziļums (mm) **140**  
 Montāžas veids **iegriežama**

IETEICAMIE PIEDERUMI

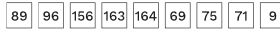

MATERIĀLS UN KRĀSAS

| KERATEK        |          | Cena € |
|----------------|----------|--------|
| Black K86      | LKB47586 | 495,-  |
| Dove Grey K93  | LKB47593 | 495,-  |
| Champagne K95  | LKB47595 | 495,-  |
| White K96      | LKB47596 | 495,-  |
| Light Grey K97 | LKB47597 | 495,-  |
| Dark Grey K99  | LKB47599 | 495,-  |

METĀLISKS

| GRANITEK      |          | Cena € |
|---------------|----------|--------|
| Titanium M73  | LMB47573 | 348,-  |
| Aluminium M79 | LMB47579 | 348,-  |

MATĒTS

|              |          |       |
|--------------|----------|-------|
| Nero G40     | LGB47540 | 348,- |
| Tortora G43  | LGB47543 | 348,- |
| Cemento G48  | LGB47548 | 348,- |
| Bianco G68   | LGB47568 | 348,- |
| Espresso G78 | LGB47578 | 348,- |

KLASISKS

|                   |          |       |
|-------------------|----------|-------|
| Avena G51         | LGB47551 | 348,- |
| Antracite G59     | LGB47559 | 348,- |
| Bianco Antico G62 | LGB47562 | 348,- |

BEST 400



White  
K96

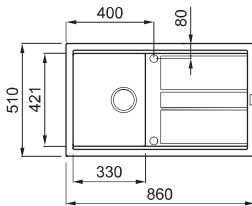

Izmērs (mm) **860 x 510**  
 Skapīša platums (mm) **450**  
 Izgriezums (mm) **840 x 480**  
 Bļodas 1 dziļums (mm) **200**  
 Montāžas veids **iegriežama**

IETEICAMIE PIEDERUMI

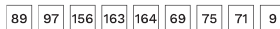

MATERIĀLS UN KRĀSAS

| KERATEK        |          | Cena € |
|----------------|----------|--------|
| Black K86      | LKB40086 | 433,-  |
| Dove Grey K93  | LKB40093 | 433,-  |
| Champagne K95  | LKB40095 | 433,-  |
| White K96      | LKB40096 | 433,-  |
| Light Grey K97 | LKB40097 | 433,-  |
| Dark Grey K99  | LKB40099 | 433,-  |

METĀLISKS

| GRANITEK      |          | Cena € |
|---------------|----------|--------|
| Titanium M73  | LMB40073 | 309,-  |
| Aluminium M79 | LMB40079 | 309,-  |

MATĒTS

|              |          |       |
|--------------|----------|-------|
| Nero G40     | LGB40040 | 309,- |
| Tortora G43  | LGB40043 | 309,- |
| Cemento G48  | LGB40048 | 309,- |
| Bianco G68   | LGB40068 | 309,- |
| Espresso G78 | LGB40078 | 309,- |

KLASISKS

|                   |          |       |
|-------------------|----------|-------|
| Avena G51         | LGB40051 | 309,- |
| Antracite G59     | LGB40059 | 309,- |
| Bianco Antico G62 | LGB40062 | 309,- |

## BEST 450



Nero  
G40

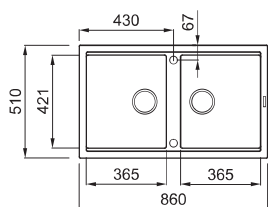

Izmērs (mm) **860 x 510**  
 Skapiša platums (mm) **900**  
 Izgriezums (mm) **840 x 480**  
 Bļodas dziļums (mm) **200**  
 Montāžas veids **Iegriežama**

### IETEICAMIE PIEDERUMI

89 96 156 163 164 69 75 71 9

### MATERIĀLS UN KRĀSAS

| KERATEK        |          | Cena € |
|----------------|----------|--------|
| Black K86      | LKB45086 | 470,-  |
| Dove Grey K93  | LKB45093 | 470,-  |
| Champagne K95  | LKB45095 | 470,-  |
| White K96      | LKB45096 | 470,-  |
| Light Grey K97 | LKB45097 | 470,-  |
| Dark Grey K99  | LKB45099 | 470,-  |

### METĀLISKS

| GRANITEK      |          | Cena € |
|---------------|----------|--------|
| Titanium M73  | LMB45073 | 321,-  |
| Aluminium M79 | LMB45079 | 321,-  |

### MATĒTS

|              |          |       |
|--------------|----------|-------|
| Nero G40     | LGB45040 | 321,- |
| Tortora G43  | LGB45043 | 321,- |
| Cemento G48  | LGB45048 | 321,- |
| Bianco G68   | LGB45068 | 321,- |
| Espresso G78 | LGB45078 | 321,- |

### KLASISKS

|                   |          |       |
|-------------------|----------|-------|
| Avena G51         | LGB45051 | 321,- |
| Antracite G59     | LGB45059 | 321,- |
| Bianco Antico G62 | LGB45062 | 321,- |

## BEST 450 PABŪVĒJAMA



Nero  
G40

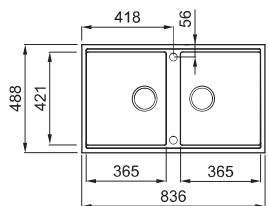

Izmērs (mm) **836 x 488**  
 Skapiša platums (mm) **900**  
 Izgriezums (mm) **795 x 448 R6**  
 Bļodas dziļums (mm) **200**  
 Montāžas veids **Pabūvējama**

### IETEICAMIE PIEDERUMI

89 156 163 164 69 75 71 9

### MATERIĀLS UN KRĀSAS

| KERATEK        |             | Cena € |
|----------------|-------------|--------|
| Black K86      | LKB45086BSO | 470,-  |
| Dove Grey K93  | LKB45093BSO | 470,-  |
| Champagne K95  | LKB45095BSO | 470,-  |
| White K96      | LKB45096BSO | 470,-  |
| Light Grey K97 | LKB45097BSO | 470,-  |
| Dark Grey K99  | LKB45099BSO | 470,-  |

### METĀLISKS

| GRANITEK      |             | Cena € |
|---------------|-------------|--------|
| Titanium M73  | LMB45073BSO | 334,-  |
| Aluminium M79 | LMB45079BSO | 334,-  |

### MATĒTS

|              |             |       |
|--------------|-------------|-------|
| Nero G40     | LGB45040BSO | 334,- |
| Tortora G43  | LGB45043BSO | 334,- |
| Cemento G48  | LGB45048BSO | 334,- |
| Bianco G68   | LGB45068BSO | 334,- |
| Espresso G78 | LGB45078BSO | 334,- |

### KLASISKS

|                   |             |       |
|-------------------|-------------|-------|
| Avena G51         | LGB45051BSO | 334,- |
| Antracite G59     | LGB45059BSO | 334,- |
| Bianco Antico G62 | LGB45062BSO | 334,- |



Izlietne Best 480 Titanium M73 | Maisītājs Stream Hromēts

KOLEKCIJA  
**UNICO**



PAPILDUS  
INFORMĀCIJA  
UNICO



**SLAVĒJOT UNIKALITĀTI**

Unikāls ir maģisks vārds. Būt unikālam nozīmē iztēloties un radīt produktus un telpas, kas iepriekš neeksistēja, justies labāk sevi, izmēģināt ceļus, kurus iepriekš neesat izmantojis, lai atklātu jaunu ceļu. Tas ir priekš Jums.

PLUS UNICO



XL BĻODA



ELEMENT  
PIEDERUMI



INTEGRĒTA  
MAISĪTĀJA  
VIETA

**GRANITEK**  
NATURAL GRANITE EFFECT

● **Nero Metal**  
M70

● **Titanium**  
M73

● **Aluminium**  
M79

● **Nero**  
G40

● **Tortora**  
G43

● **Cemento**  
G48

○ **Bianco**  
G68

● **Espresso**  
G78

● **Avena**  
G51

● **Antracite**  
G59

● **Bianco Antico**  
G62

**KERATEK**  
CERAMIC NANOTECHNOLOGY CN6

● **Black**  
K86

● **Dove Grey**  
K93

○ **White**  
K96

● **Light Grey**  
K97



## MODELIS UNICO

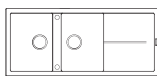

UNICO 500

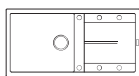

UNICO 480

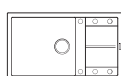

UNICO 410

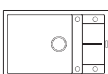

UNICO 310

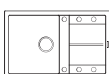

UNICO 300



UNICO 125

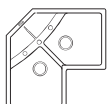

UNICO CORNER

**Komplektā:** Vietu taupošs sifons, ventiļu sistēma ar apaļu pārplūdi un montāžas āķi.

## IETEICAMIE PIEDERUMI

88

**50 cm GRIEŽAMĀIS  
DĒLIS  
ELEMENT  
ATH010QU**  
108. Lpp.



**Apdare**

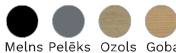

Melns Pelēks Ozols Goba

156

**LOKANAIS PAKLĀJS  
FLEX 500 ELEMENT  
ARS023BK**  
110. Lpp.



**Apdare**



Melns

97

**SPIEDPOGA  
ELEMENT  
ASPI3002BK**  
113. Lpp.



**Apdare**



Hromēts Melns

75

**GROZS**

ACI01307  
117. Lpp.



\*Lai iegūtu plašāku informāciju, skatiet piederumu sadaļu 106. lappusē

## PERFEKTI SADERĪGS ŪDENS MAISĪTĀJS



**TRAIL – Cemento G48**  
MGKTRA48

125. Lpp.

Pieejamās krāsas



## PAPILDUS

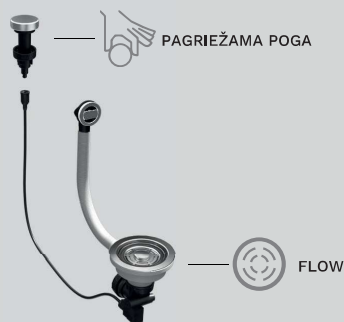

**ELEMENT KOMPLEKTS  
VADĪBAS KONTROLE ATVER  
PAGRIEŽOT OPEN-TWIST ELEMENT**  
Art.KITASP-FB-IVTELL-IN

114. Lpp.

## elleci | BEAUTY



Produktu linija, kas īpaši izstrādāta kompozitmateriālu izlietņu kopšanai.

Vairāk informācijas 140.lpp.

## UNICO 500



Titanium  
M73

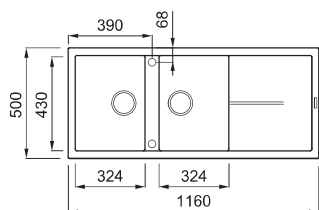

Izmērs (mm) **1160 x 500**  
 Skapiša platums (mm) **800**  
 Izgriezums (mm) **1140 x 480**  
 Bļodas dziļums (mm) **200**  
 Montāžas veids **legriežama**

### IETEICAMIE PIEDERUMI

|    |    |     |     |   |   |    |    |   |
|----|----|-----|-----|---|---|----|----|---|
| 88 | 96 | 156 | 163 | 4 | 5 | 75 | 71 | 9 |
|----|----|-----|-----|---|---|----|----|---|

### MATERIĀLS UN KRĀSAS

| KERATEK        |          | Cena € |
|----------------|----------|--------|
| Black K86      | LKU50086 | 432,-  |
| Dove Grey K93  | LKU50093 | 432,-  |
| White K96      | LKU50096 | 432,-  |
| Light Grey K97 | LKU50097 | 432,-  |

### GRANITEK

| GRANITEK       |          | Cena € |
|----------------|----------|--------|
| Nero Metal M70 | LMU50070 | 309,-  |
| Titanium M73   | LMU50073 | 309,-  |
| Aluminium M79  | LMU50079 | 309,-  |

| MATĒTS       |          | Cena € |
|--------------|----------|--------|
| Nero G40     | LGU50040 | 309,-  |
| Tortora G43  | LGU50043 | 309,-  |
| Cemento G48  | LGU50048 | 309,-  |
| Bianco G68   | LGU50068 | 309,-  |
| Espresso G78 | LGU50078 | 309,-  |

| KLASISKS          |          | Cena € |
|-------------------|----------|--------|
| Avena G51         | LGU50051 | 309,-  |
| Antracite G59     | LGU50059 | 309,-  |
| Bianco Antico G62 | LGU50062 | 309,-  |

## UNICO 480



Titanium  
M73

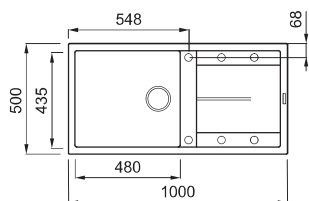

Izmērs (mm) **1000 x 500**  
 Skapiša platums (mm) **600**  
 Izgriezums (mm) **980 x 480**  
 Bļodas dziļums (mm) **200**  
 Montāžas veids **legriežama**

### IETEICAMIE PIEDERUMI

|    |    |    |     |     |     |   |   |
|----|----|----|-----|-----|-----|---|---|
| 88 | 97 | 25 | 50  | 156 | 163 | 4 | 5 |
| 75 | 43 | 9  | 194 | 195 |     |   |   |

### MATERIĀLS UN KRĀSAS

| KERATEK        |          | Cena € |
|----------------|----------|--------|
| Black K86      | LKU48086 | 371,-  |
| Dove Grey K93  | LKU48093 | 371,-  |
| White K96      | LKU48096 | 371,-  |
| Light Grey K97 | LKU48097 | 371,-  |

### GRANITEK

| GRANITEK       |          | Cena € |
|----------------|----------|--------|
| Nero Metal M70 | LMU48070 | 282,-  |
| Titanium M73   | LMU48073 | 282,-  |
| Aluminium M79  | LMU48079 | 282,-  |

| MATĒTS       |          | Cena € |
|--------------|----------|--------|
| Nero G40     | LGU48040 | 282,-  |
| Tortora G43  | LGU48043 | 282,-  |
| Cemento G48  | LGU48048 | 282,-  |
| Bianco G68   | LGU48068 | 282,-  |
| Espresso G78 | LGU48078 | 282,-  |

| KLASISKS          |          | Cena € |
|-------------------|----------|--------|
| Avena G51         | LGU48051 | 282,-  |
| Antracite G59     | LGU48059 | 282,-  |
| Bianco Antico G62 | LGU48062 | 282,-  |

## UNICO 410



Aluminium  
M79

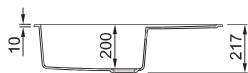
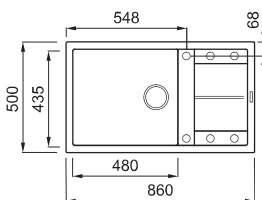

Izmērs (mm) **860 x 500**  
 Skapiša platums (mm) **600**  
 Izgriezums (mm) **840 x 480**  
 Bļodas dziļums (mm) **200**  
 Montāžas veids **iegriežama**

### IETEICAMIE PIEDERUMI

|    |    |    |     |     |     |   |   |
|----|----|----|-----|-----|-----|---|---|
| 88 | 97 | 25 | 50  | 156 | 163 | 4 | 5 |
| 75 | 43 | 9  | 194 | 195 |     |   |   |

### MATERIĀLS UN KRĀSAS

| KERATEK        |          | Cena € |
|----------------|----------|--------|
| Black K86      | LKU41086 | 326,-  |
| Dove Grey K93  | LKU41093 | 326,-  |
| White K96      | LKU41096 | 326,-  |
| Light Grey K97 | LKU41097 | 326,-  |

### GRANITEK

| GRANITEK       |          | Cena € |
|----------------|----------|--------|
| Nero Metal M70 | LMU41070 | 267,-  |
| Titanium M73   | LMU41073 | 267,-  |
| Aluminium M79  | LMU41079 | 267,-  |

METĀLISKS

MATĒTS

|              |          |       |
|--------------|----------|-------|
| Nero G40     | LGU41040 | 267,- |
| Tortora G43  | LGU41043 | 267,- |
| Cemento G48  | LGU41048 | 267,- |
| Bianco G68   | LGU41068 | 267,- |
| Espresso G78 | LGU41078 | 267,- |

KLASISKS

|                   |          |       |
|-------------------|----------|-------|
| Avena G51         | LGU41051 | 267,- |
| Antracite G59     | LGU41059 | 267,- |
| Bianco Antico G62 | LGU41062 | 267,- |

## UNICO 310



Aluminium  
M79

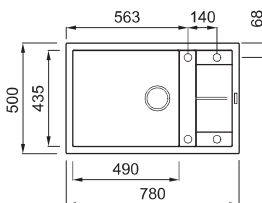

Izmērs (mm) **780 x 500**  
 Skapiša platums (mm) **600 ||| 800 ja pirmais skapis**  
 Izgriezums (mm) **760 x 480**  
 Bļodas dziļums (mm) **200**  
 Montāžas veids **iegriežama**

### IETEICAMIE PIEDERUMI

|    |    |    |     |     |     |   |   |
|----|----|----|-----|-----|-----|---|---|
| 88 | 97 | 25 | 50  | 156 | 163 | 4 | 5 |
| 75 | 43 | 9  | 194 | 195 |     |   |   |

### MATERIĀLS UN KRĀSAS

| KERATEK        |          | Cena € |
|----------------|----------|--------|
| Black K86      | LKU31086 | 319,-  |
| Dove Grey K93  | LKU31093 | 319,-  |
| White K96      | LKU31096 | 319,-  |
| Light Grey K97 | LKU31097 | 319,-  |

### GRANITEK

| GRANITEK       |          | Cena € |
|----------------|----------|--------|
| Nero Metal M70 | LMU31070 | 265,-  |
| Titanium M73   | LMU31073 | 265,-  |
| Aluminium M79  | LMU31079 | 265,-  |

METĀLISKS

MATĒTS

|              |          |       |
|--------------|----------|-------|
| Nero G40     | LGU31040 | 265,- |
| Tortora G43  | LGU31043 | 265,- |
| Cemento G48  | LGU31048 | 265,- |
| Bianco G68   | LGU31068 | 265,- |
| Espresso G78 | LGU31078 | 265,- |

KLASISKS

|                   |          |       |
|-------------------|----------|-------|
| Avena G51         | LGU31051 | 265,- |
| Antracite G59     | LGU31059 | 265,- |
| Bianco Antico G62 | LGU31062 | 265,- |

## UNICO 300



Nero  
G40

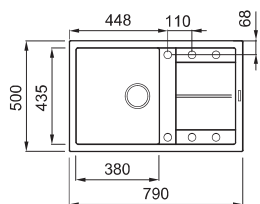

Izmērs (mm) **790 x 500**  
Skapiša platums (mm) **500**  
Izgriezums (mm) **770 x 480**  
Blodas dziļums (mm) **200**  
Montāžas veids **legriežama**

### IETEICAMIE PIEDERUMI

|    |    |    |     |     |     |   |   |
|----|----|----|-----|-----|-----|---|---|
| 88 | 97 | 25 | 50  | 156 | 163 | 4 | 5 |
| 75 | 71 | 9  | 194 | 195 |     |   |   |

### MATERIĀLS UN KRĀSAS

| KERATEK        |          | Cena € |
|----------------|----------|--------|
| Black K86      | LKU30086 | 313,-  |
| Dove Grey K93  | LKU30093 | 313,-  |
| White K96      | LKU30096 | 313,-  |
| Light Grey K97 | LKU30097 | 313,-  |

### GRANITEK

| GRANITEK                        |          | Cena € |
|---------------------------------|----------|--------|
| <b>METĀLISKS</b> Nero Metal M70 | LMU30070 | 254,-  |
| Titanium M73                    | LMU30073 | 254,-  |
| Aluminium M79                   | LMU30079 | 254,-  |

| MATĒTS       |          | Cena € |
|--------------|----------|--------|
| Nero G40     | LGU30040 | 254,-  |
| Tortora G43  | LGU30043 | 254,-  |
| Cemento G48  | LGU30048 | 254,-  |
| Bianco G68   | LGU30068 | 254,-  |
| Espresso G78 | LGU30078 | 254,-  |

| KLASISKS          |          | Cena € |
|-------------------|----------|--------|
| Avena G51         | LGU30051 | 254,-  |
| Antracite G59     | LGU30059 | 254,-  |
| Bianco Antico G62 | LGU30062 | 254,-  |

## UNICO 125



Nero  
G40

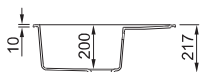
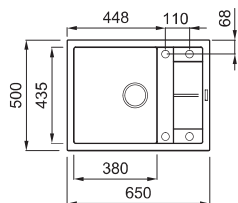

Izmērs (mm) **650 x 500**  
Skapiša platums (mm) **500**  
Izgriezums (mm) **630 x 480**  
Blodas dziļums (mm) **200**  
Montāžas veids **legriežama**

### IETEICAMIE PIEDERUMI

|    |    |    |     |     |     |   |   |
|----|----|----|-----|-----|-----|---|---|
| 88 | 97 | 25 | 50  | 156 | 163 | 4 | 5 |
| 75 | 71 | 9  | 194 | 195 |     |   |   |

### MATERIĀLS UN KRĀSAS

| KERATEK        |          | Cena € |
|----------------|----------|--------|
| Black K86      | LKU12586 | 278,-  |
| Dove Grey K93  | LKU12593 | 278,-  |
| White K96      | LKU12596 | 278,-  |
| Light Grey K97 | LKU12597 | 278,-  |

### GRANITEK

| GRANITEK                        |          | Cena € |
|---------------------------------|----------|--------|
| <b>METĀLISKS</b> Nero Metal M70 | LMU12570 | 222,-  |
| Titanium M73                    | LMU12573 | 222,-  |
| Aluminium M79                   | LMU12579 | 222,-  |

| MATĒTS       |          | Cena € |
|--------------|----------|--------|
| Nero G40     | LGU12540 | 222,-  |
| Tortora G43  | LGU12543 | 222,-  |
| Cemento G48  | LGU12548 | 222,-  |
| Bianco G68   | LGU12568 | 222,-  |
| Espresso G78 | LGU12578 | 222,-  |

| KLASISKS          |          | Cena € |
|-------------------|----------|--------|
| Avena G51         | LGU12551 | 222,-  |
| Antracite G59     | LGU12559 | 222,-  |
| Bianco Antico G62 | LGU12562 | 222,-  |

## UNICO CORNER



Bianco  
G68

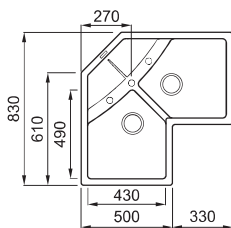

Izmērs (mm) **830 x 830**  
Skapiša platums (mm) **Stūra skapis**  
Izgriezums (mm) **Pēc šablona\***  
Blodas dziļums (mm) **190**  
Montāžas veids **iegriežama**

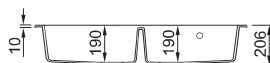

### IETEICAMIE PIEDERUMI

88 96 25 50 156 163 4 5 75 9

### MATERIĀLS UN KRĀSAS

**GRANITEK**  
NATURAL GRANITE EFFECT

| METĀLISKS        | Modelis  | Cena € |
|------------------|----------|--------|
| ● Nero Metal M70 | LMUCOR70 | 371,-  |
| ● Titanium M73   | LMUCOR73 | 371,-  |
| ● Aluminium M79  | LMUCOR79 | 371,-  |

| MATĒTS         | Modelis  | Cena € |
|----------------|----------|--------|
| ● Nero G40     | LGUCOR40 | 371,-  |
| ● Tortora G43  | LGUCOR43 | 371,-  |
| ● Cemento G48  | LGUCOR48 | 371,-  |
| ● Bianco G68   | LGUCOR68 | 371,-  |
| ● Espresso G78 | LGUCOR78 | 371,-  |

| KLASISKS            | Modelis  | Cena € |
|---------------------|----------|--------|
| ● Avena G51         | LGUCOR51 | 371,-  |
| ● Antracite G59     | LGUCOR59 | 371,-  |
| ● Bianco Antico G62 | LGUCOR62 | 371,-  |

\*Šablons iekļauts komplektā vai arī pieejams lejupielādeino vietnes [www.elleci.com/it](http://www.elleci.com/it) īpašās lejupielādes sadaļas



Izlietne Unico Corner Nero G40 | Maisītājs Trail Plus Nero G40

KOLEKCIJA  
**EGO**



PAPILDUS  
INFORMĀCIJA  
EGO



**VALDZINOŠS DIZAINS**

Izlietņu kolekcija, kas paredzēta maigākām garšām. Līnijas ir ļoti smalkas un veido līknes, kas rada valdzinošu dizainu. Katru modeli var kombinēt ar dažādu aksesuāru klāstu un dažādām krāsām.

PLUS **EGO**



ELEMENT  
PIEDERUMI



PIEVILCĪGS  
DIZAINS

**GRANITEK**

NATURAL GRANITE EFFECT

● **Nero Metal**  
M70

● **Titanium**  
M73

● **Aluminium**  
M79

● **Nero**  
G40

● **Tortora**  
G43

● **Cemento**  
G48

○ **Bianco**  
G68

● **Espresso**  
G78

● **Avena**  
G51

● **Antracite**  
G59

● **Bianco Antico**  
G62

## MODELIS EGO

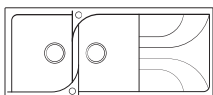

EGO 500

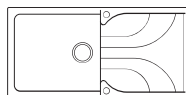

EGO 480

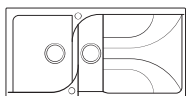

EGO 475

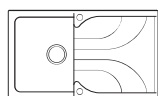

EGO 400

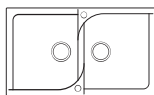

EGO 450



EGO ROUND

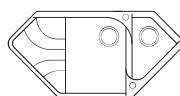

EGO CORNER

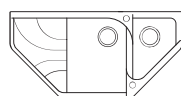

EGO ESA

**Komplektā:** Vietu taupošs sifons, ventiļu sistēma ar apaļu pārplūdi un montāžas āķi.

## IETEICAMIE PIEDERUMI

88

**GRIEŽAMĀIS DĒLIS  
ELEMENT  
ATH010QU**

108.Lpp.



**Apdare**



Melns Pelēks Ozols Goba

156

**LOKANĀIS PAKLĀJS  
FLEX 500 ELEMENT  
ARS023BK**

110.Lpp.



**Apdare**



Melns

96

**SPIEDPOGA ELEMENT  
2 BĻODĀM  
ASP23002**

113.Lpp.



**Apdare**



Hromēts Melns

5

**CAURDURIS**

AVI03001  
116.Lpp.



\*Lai iegūtu plašāku informāciju, skatiet piederumu sadaļu 106. lappusē

## PERFEKTI SADERĪGS ŪDENS MAISĪTĀJS



**VOLTA – Titanium M73**  
MMKVTA73

130.Lpp.

Pieejamās krāsas



## PAPILDUS



**ELEMENT KOMPLEKTS  
VADĪBAS KONTROLE ATVER  
PAGRIEŽOT OPEN-TWIST ELEMENT**  
Art. KITASP-FB-IVTELL-IN

114. Lpp.

## elleci | BEAUTY



Produktu linija, kas īpaši izstrādāta kompozitmateriālu izlietņu kopšanai.

Vairāk informācijas 140.lpp.

## EGO 500



Nero  
G40

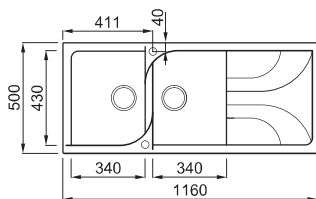

Izmērs (mm) **1160 x 500**  
 Skapiša platums (mm) **800**  
 Izgriezums (mm) **1140 x 485**  
 Bļodas dziļums (mm) **210**  
 Montāžas veids **legriežama**



### IETEICAMIE PIEDERUMI

88 96 156 163 4 5 75 9

### MATERIĀLS UN KRĀSAS

**GRANITEK**  
NATURAL GRANITE EFFECT

|           |                     |          | Cena € |
|-----------|---------------------|----------|--------|
| METĀLISKS | ● Nero Metal M70    | LME50070 | 321,-  |
|           | ● Titanium M73      | LME50073 | 321,-  |
|           | ● Aluminium M79     | LME50079 | 321,-  |
| MATĒTS    | ● Nero G40          | LGE50040 | 321,-  |
|           | ● Tortora G43       | LGE50043 | 321,-  |
|           | ● Cemento G48       | LGE50048 | 321,-  |
|           | ● Bianco G68        | LGE50068 | 321,-  |
| KLASISKS  | ● Avena G51         | LGE50051 | 321,-  |
|           | ● Antracite G59     | LGE50059 | 321,-  |
|           | ● Bianco Antico G62 | LGE50062 | 321,-  |

## EGO 480



Nero  
G40

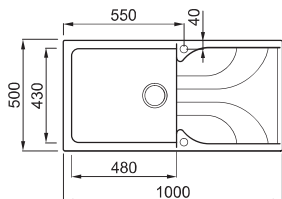

Izmērs (mm) **1000 x 500**  
 Skapiša platums (mm) **600**  
 Izgriezums (mm) **980 x 485**  
 Bļodas dziļums (mm) **210**  
 Montāžas veids **legriežama**



### IETEICAMIE PIEDERUMI

88 97 156 163 4 5 75 43 9  
 194 195

### MATERIĀLS UN KRĀSAS

**GRANITEK**  
NATURAL GRANITE EFFECT

|           |                     |          | Cena € |
|-----------|---------------------|----------|--------|
| METĀLISKS | ● Nero Metal M70    | LME48070 | 299,-  |
|           | ● Titanium M73      | LME48073 | 299,-  |
|           | ● Aluminium M79     | LME48079 | 299,-  |
| MATĒTS    | ● Nero G40          | LGE48040 | 299,-  |
|           | ● Tortora G43       | LGE48043 | 299,-  |
|           | ● Cemento G48       | LGE48048 | 299,-  |
|           | ● Bianco G68        | LGE48068 | 299,-  |
| KLASISKS  | ● Avena G51         | LGE48051 | 299,-  |
|           | ● Antracite G59     | LGE48059 | 299,-  |
|           | ● Bianco Antico G62 | LGE48062 | 299,-  |



elleci | VIRTUVE

EGO 475



Bianco  
G68

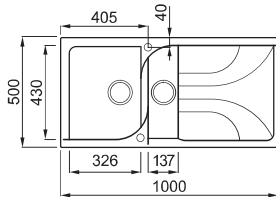

Izmērs (mm) **1000 x 500**  
 Skapīša platums (mm) **600**  
 Izgriezums (mm) **980 x 485**  
 Bļodas 1 dziļums (mm) **210**  
 Bļodas 2 dziļums (mm) **155**  
 Montāžas veids **legriežama**

IETEICAMIE PIEDERUMI

88 96 156 163 4 5 75 71 9

MATERIĀLS UN KRĀSAS

**GRANITEK**  
NATURAL GRANITE EFFECT

| METĀLISKS        | Modelis  | Cena € |
|------------------|----------|--------|
| ● Nero Metal M70 | LME47570 | 297,-  |
| ● Titanium M73   | LME47573 | 297,-  |
| ● Aluminium M79  | LME47579 | 297,-  |

| MATĒTS        | Modelis  | Cena € |
|---------------|----------|--------|
| ● Nero G40    | LGE47540 | 297,-  |
| ● Tortora G43 | LGE47543 | 297,-  |
| ● Cemento G48 | LGE47548 | 297,-  |
| ● Bianco G68  | LGE47568 | 297,-  |

| KLASISKS            | Modelis  | Cena € |
|---------------------|----------|--------|
| ● Avena G51         | LGE47551 | 297,-  |
| ● Antracite G59     | LGE47559 | 297,-  |
| ● Bianco Antico G62 | LGE47562 | 297,-  |

EGO 400



Bianco  
G68

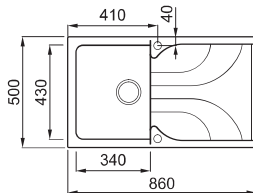

Izmērs (mm) **860 x 500**  
 Skapīša platums (mm) **450**  
 Izgriezums (mm) **840 x 490**  
 Bļodas dziļums (mm) **210**  
 Montāžas veids **legriežama**

IETEICAMIE PIEDERUMI

88 97 163 4 5 75 71 9 194 195

MATERIĀLS UN KRĀSAS

**GRANITEK**  
NATURAL GRANITE EFFECT

| METĀLISKS        | Modelis  | Cena € |
|------------------|----------|--------|
| ● Nero Metal M70 | LME40070 | 263,-  |
| ● Titanium M73   | LME40073 | 263,-  |
| ● Aluminium M79  | LME40079 | 263,-  |

| MATĒTS        | Modelis  | Cena € |
|---------------|----------|--------|
| ● Nero G40    | LGE40040 | 263,-  |
| ● Tortora G43 | LGE40043 | 263,-  |
| ● Cemento G48 | LGE40048 | 263,-  |
| ● Bianco G68  | LGE40068 | 263,-  |

| KLASISKS            | Modelis  | Cena € |
|---------------------|----------|--------|
| ● Avena G51         | LGE40051 | 263,-  |
| ● Antracite G59     | LGE40059 | 263,-  |
| ● Bianco Antico G62 | LGE40062 | 263,-  |

## EGO 450



Bianco  
G68

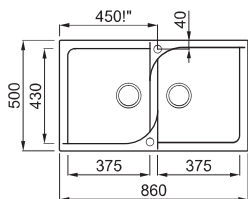

Izmērs (mm) **860 x 500**  
 Skapiša platums (mm) **900**  
 Izgriezums (mm) **840 x 485**  
 Bļodas dziļums (mm) **210**  
 Montāžas veids **legriežama**

### IETEICAMIE PIEDERUMI

88 96 156 163 4 5 75 71 9

### MATERIĀLS UN KRĀSAS

**GRANITEK**  
NATURAL GRANITE EFFECT

| METĀLISKS        | Modelis  | Cena € |
|------------------|----------|--------|
| ● Nero Metal M70 | LME45070 | 282,-  |
| ● Titanium M73   | LME45073 | 282,-  |
| ● Aluminium M79  | LME45079 | 282,-  |

| MATĒTS        | Modelis  | Cena € |
|---------------|----------|--------|
| ● Nero G40    | LGE45040 | 282,-  |
| ● Tortora G43 | LGE45043 | 282,-  |
| ● Cemento G48 | LGE45048 | 282,-  |
| ○ Bianco G68  | LGE45068 | 282,-  |

| KLASISKS            | Modelis  | Cena € |
|---------------------|----------|--------|
| ● Avena G51         | LGE45051 | 282,-  |
| ● Antracite G59     | LGE45059 | 282,-  |
| ● Bianco Antico G62 | LGE45062 | 282,-  |

## Avena

## EGO ROUND



Bianco  
G68

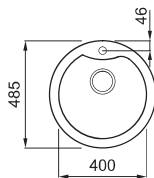

Izmērs (mm) **Ø 485**  
 Skapiša platums (mm) **500**  
 Izgriezums (mm) **Ø 465**  
 Bļodas dziļums (mm) **210**  
 Montāžas veids **legriežama**

### IETEICAMIE PIEDERUMI

163 8 194

### MATERIĀLS UN KRĀSAS

**GRANITEK**  
NATURAL GRANITE EFFECT

| METĀLISKS        | Modelis  | Cena € |
|------------------|----------|--------|
| ● Nero Metal M70 | LMEROU70 | 222,-  |
| ● Titanium M73   | LMEROU73 | 222,-  |
| ● Aluminium M79  | LMEROU79 | 222,-  |

| MATĒTS        | Modelis  | Cena € |
|---------------|----------|--------|
| ● Nero G40    | LGEROU40 | 222,-  |
| ● Tortora G43 | LGEROU43 | 222,-  |
| ○ Bianco G68  | LGEROU68 | 222,-  |

| KLASISKS            | Modelis  | Cena € |
|---------------------|----------|--------|
| ● Avena G51         | LGEROU51 | 222,-  |
| ● Antracite G59     | LGEROU59 | 222,-  |
| ● Bianco Antico G62 | LGEROU62 | 222,-  |

## EGO CORNER



Titanium  
M73

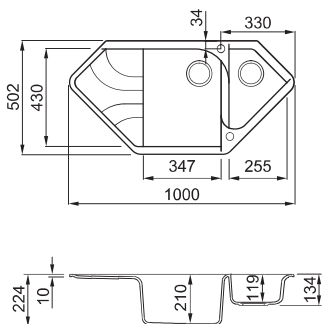

Izmērs (mm)  
Skapiša platums (mm)  
- Ja taisnā virsmā

**1000 x 500**  
**Stūra skapis**  
**800 III 1200 ja pirmais**  
**skapis pa kreisi**  
**800 ja pirmais**  
**skapis pa labi**  
**Pēc šablona**  
Bļodas 1 dziļums (mm)  
**210**  
Bļodas 2 dziļums (mm)  
**120**  
Montāžas veids  
**legriežama**

### IETEICAMIE PIEDERUMI

88 96 163 5 75 9

\* Šablons iekļauts komplektā vai arī pieejams lejuplādei no vietnes [www.elleci.com/it](http://www.elleci.com/it) īpašās lejuplādes sadaļas

### MATERIĀLS UN KRĀSAS

**GRANITEK**  
NATURAL GRANITE EFFECT

|           |  |                |          |              |        |
|-----------|--|----------------|----------|--------------|--------|
| METĀLISKS |  | Nero Metal M70 | LMECOR70 | <b>346,-</b> | Cena € |
|           |  | Titanium M73   | LMECOR73 | <b>346,-</b> |        |
|           |  | Aluminium M79  | LMECOR79 | <b>346,-</b> |        |

|        |  |             |          |              |
|--------|--|-------------|----------|--------------|
| MATĒTS |  | Nero G40    | LGECOR40 | <b>346,-</b> |
|        |  | Tortora G43 | LGECOR43 | <b>346,-</b> |
|        |  | Cemento G68 | LGECOR68 | <b>346,-</b> |

|          |  |                   |          |              |
|----------|--|-------------------|----------|--------------|
| KLASISKS |  | Avena G51         | LGECOR51 | <b>346,-</b> |
|          |  | Antracite G59     | LGECOR59 | <b>346,-</b> |
|          |  | Bianco Antico G62 | LGECOR62 | <b>346,-</b> |

## EGO ESA



Titanium  
M73

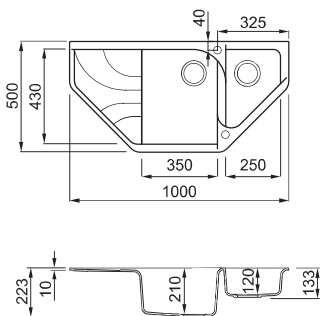

Izmērs (mm)  
Skapiša platums (mm)

**1000 x 500**  
**800 III 1200 ja pirmais**  
**skapis pa kreisi**  
**800 ja pirmais**  
**skapis pa labi**  
**Pēc šablona**  
Bļodas 1 dziļums (mm)  
**210**  
Bļodas 2 dziļums (mm)  
**120**  
Montāžas veids  
**legriežama**

### IETEICAMIE PIEDERUMI

88 96 163 5 75 9

\* Šablons iekļauts komplektā vai arī pieejams lejuplādei no vietnes [www.elleci.com/it](http://www.elleci.com/it) īpašās lejuplādes sadaļas

### MATERIĀLS UN KRĀSAS

**GRANITEK**  
NATURAL GRANITE EFFECT

|           |  |                |          |              |        |
|-----------|--|----------------|----------|--------------|--------|
| METĀLISKS |  | Nero Metal M70 | LMEESA70 | <b>312,-</b> | Cena € |
|           |  | Titanium M73   | LMEESA73 | <b>312,-</b> |        |
|           |  | Aluminium M79  | LMEESA79 | <b>312,-</b> |        |

|        |  |             |           |              |
|--------|--|-------------|-----------|--------------|
| MATĒTS |  | Nero G40    | LGEEESA40 | <b>312,-</b> |
|        |  | Tortora G43 | LGEEESA43 | <b>312,-</b> |
|        |  | Bianco G68  | LGEEESA68 | <b>312,-</b> |

|          |  |                   |           |              |
|----------|--|-------------------|-----------|--------------|
| KLASISKS |  | Avena G51         | LGEEESA51 | <b>312,-</b> |
|          |  | Antracite G59     | LGEEESA59 | <b>312,-</b> |
|          |  | Bianco Antico G62 | LGEEESA62 | <b>312,-</b> |

KOLEKCIJA  
**EASY**



PAPILDUS  
INFORMĀCIJA  
EASY



**LAIKA GAITĀ PĀRBAUDĪTS**

Unikāls produkts ar izteiktu novatorisku raksturu, kas nemanāmi integrē ārkārtēju funkcionalitāti ar spēju "pielāgoties" lietotāja vajadzībām tiktāl, ka tas var pilnībā "pazust".

PLUS **EASY**



XL BĻODA



ELEMENT  
PIEDERUMI



PRISMA  
CLEAN



ĪPAŠS  
DIZAINS

**GRANITEK**

NATURAL GRANITE EFFECT

● **Nero Metal**  
M70

● **Titanium**  
M73

● **Aluminium**  
M79

● **Nero**  
G40

● **Tortora**  
G43

● **Cemento**  
G48

○ **Bianco**  
G68

● **Espresso**  
G78

● **Avena**  
G51

● **Antracite**  
G59

● **Bianco Antico**  
G62

## MODELIS EASY

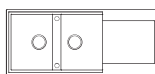

EASY 500

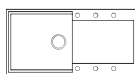

EASY 480

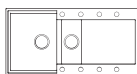

EASY 475

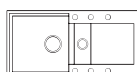

EASY 425

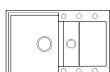

EASY 325

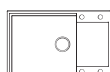

EASY 310

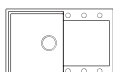

EASY 300

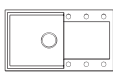

EASY 290



EASY 150



EASY 135

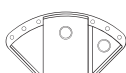

EASY CORNER



EASY 600 ROUND

**Komplektā:** Vietu taupošs sifons, ventiļu sistēma ar apaļu pārplūdi un montāžas āķi.

## IETEICAMIE PIEDERUMI

88

**50 cm GIRŽAMĀIS  
DĒLIS  
ELEMENT**  
ATH010QU  
108.Lpp.



**Apdare**



Melns Pelēks Ozols Goba

156

**LOKANAIS PAKLĀJS  
FLEX 500 ELEMENT**  
ARS023BK  
110.Lpp.



**Apdare**



Melns

97

**SPIEDPOGA  
ELEMENT**  
ASP13002BK  
113.Lpp.



**Apdare**



Hromēts Melns

5

**CAURDURIS**

AVI03001  
116.Lpp.



\*Lai iegūtu plašāku informāciju, skatiet piederumu sadaļu 106. lappusē

## PERFEKTI SADERĪGS ŪDENS MAISĪTĀJS



**ATHENA – Tortora G43**  
MGKATH43

127.Lpp.

Pieejamās krāsas



## PAPILDUS



**ELEMENT KOMPLEKTS  
VADĪBAS KONTROLE ATVER  
PAGRIEŽOT OPEN-TWIST ELEMENT**  
Art. KITASP-FB-IVTELL-IN

114.Lpp.

## elleci | BEAUTY



Produktu linija, kas īpaši izstrādāta kompozitmateriālu izlietņu kopšanai.

Vairāk informācijas 140.lpp.

## EASY 500



Nero  
G40

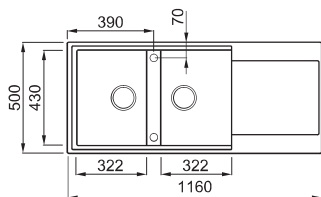

Izmērs (mm) **1160 x 500**  
 Skapiša platums (mm) **800**  
 Izgriezums (mm) **1140 x 480**  
 Bļodas dziļums (mm) **200**  
 Montāžas veids **legriežama**

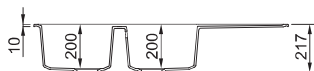

### IETEICAMIE PIEDERUMI

|    |    |     |     |   |   |    |   |
|----|----|-----|-----|---|---|----|---|
| 88 | 96 | 156 | 163 | 4 | 5 | 75 | 9 |
|----|----|-----|-----|---|---|----|---|

### MATERIĀLS UN KRĀSAS

**GRANITEK**  
NATURAL GRANITE EFFECT

|           |                     |          | Cena € |
|-----------|---------------------|----------|--------|
| METĀLISKS | ● Nero Metal M70    | LMY50070 | 309,-  |
|           | ● Titanium M73      | LMY50073 | 309,-  |
|           | ● Aluminium M79     | LMY50079 | 309,-  |
| MATĒTS    | ● Nero G40          | LGY50040 | 309,-  |
|           | ● Tortora G43       | LGY50043 | 309,-  |
|           | ● Cemento G48       | LGY50048 | 309,-  |
|           | ● Bianco G68        | LGY50068 | 309,-  |
|           | ● Espresso G78      | LGY50078 | 309,-  |
| KLASISKS  | ● Avena G51         | LGY50051 | 309,-  |
|           | ● Antracite G59     | LGY50059 | 309,-  |
|           | ● Bianco Antico G62 | LGY50062 | 309,-  |

## EASY 480



Nero  
G40

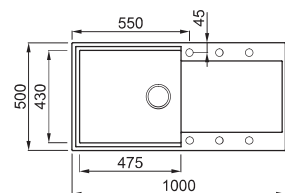

Izmērs (mm) **1000 x 500**  
 Skapiša platums (mm) **600**  
 Izgriezums (mm) **980 x 480**  
 Bļodas dziļums (mm) **200**  
 Montāžas veids **legriežama**



### IETEICAMIE PIEDERUMI

|    |     |     |    |     |     |   |   |    |
|----|-----|-----|----|-----|-----|---|---|----|
| 88 | 97  | 25  | 50 | 156 | 163 | 4 | 5 | 75 |
| 9  | 194 | 194 |    |     |     |   |   |    |

### MATERIĀLS UN KRĀSAS

**GRANITEK**  
NATURAL GRANITE EFFECT

|           |                     |          | Cena € |
|-----------|---------------------|----------|--------|
| METĀLISKS | ● Nero Metal M70    | LMY48070 | 297,-  |
|           | ● Titanium M73      | LMY48073 | 297,-  |
|           | ● Aluminium M79     | LMY48079 | 297,-  |
| MATĒTS    | ● Nero G40          | LGY48040 | 297,-  |
|           | ● Tortora G43       | LGY48043 | 297,-  |
|           | ● Cemento G48       | LGY48048 | 297,-  |
|           | ● Bianco G68        | LGY48068 | 297,-  |
|           | ● Espresso G78      | LGY48078 | 297,-  |
| KLASISKS  | ● Avena G51         | LGY48051 | 297,-  |
|           | ● Antracite G59     | LGY48059 | 297,-  |
|           | ● Bianco Antico G62 | LGY48062 | 297,-  |

## EASY 475



Bianco  
G68

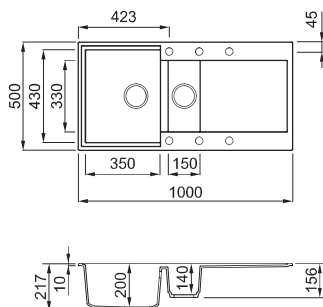

Izmērs (mm) **1000 x 500**  
 Skapiša platums (mm) **600 ||| 800 ja pirmais skapis**  
 Izgriezums (mm) **980 x 480**  
 Bļodas 1 dziļums (mm) **200**  
 Bļodas 2 dziļums (mm) **140**  
 Montāžas veids **legriežama**

### IETEICAMIE PIEDERUMI

|    |    |    |    |     |     |   |   |
|----|----|----|----|-----|-----|---|---|
| 88 | 96 | 25 | 50 | 156 | 163 | 4 | 5 |
| 75 | 9  |    |    |     |     |   |   |

### MATERIĀLS UN KRĀSAS

GRANITEK  
NATURAL GRANITE EFFECT

| METĀLISKS        | Modelis  | Cena € |
|------------------|----------|--------|
| ● Nero Metal M70 | LMY47570 | 297,-  |
| ● Titanium M73   | LMY47573 | 297,-  |
| ● Aluminium M79  | LMY47579 | 297,-  |

| MATĒTS         | Modelis  | Cena € |
|----------------|----------|--------|
| ● Nero G40     | LGY47540 | 297,-  |
| ● Tortora G43  | LGY47543 | 297,-  |
| ● Cemento G48  | LGY47548 | 297,-  |
| ● Bianco G68   | LGY47568 | 297,-  |
| ● Espresso G78 | LGY47578 | 297,-  |

| KLASISKS            | Modelis  | Cena € |
|---------------------|----------|--------|
| ● Avena G51         | LGY47551 | 297,-  |
| ● Antracite G59     | LGY47559 | 297,-  |
| ● Bianco Antico G62 | LGY47562 | 297,-  |

## EASY 425



Bianco  
G68

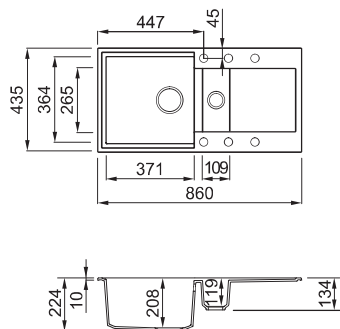

Izmērs (mm) **860 x 435**  
 Skapiša platums (mm) **600**  
 Izgriezums (mm) **840 x 415**  
 Bļodas 1 dziļums (mm) **210**  
 Bļodas 2 dziļums (mm) **120**  
 Montāžas veids **legriežama**

### IETEICAMIE PIEDERUMI

|    |    |    |     |     |   |    |   |
|----|----|----|-----|-----|---|----|---|
| 97 | 25 | 50 | 157 | 163 | 5 | 71 | 9 |
|----|----|----|-----|-----|---|----|---|

### MATERIĀLS UN KRĀSAS

GRANITEK  
NATURAL GRANITE EFFECT

| METĀLISKS        | Modelis  | Cena € |
|------------------|----------|--------|
| ● Nero Metal M70 | LMY42570 | 256,-  |
| ● Titanium M73   | LMY42573 | 256,-  |
| ● Aluminium M79  | LMY42579 | 256,-  |

| MATĒTS         | Modelis  | Cena € |
|----------------|----------|--------|
| ● Nero G40     | LGY42540 | 256,-  |
| ● Tortora G43  | LGY42543 | 256,-  |
| ● Cemento G48  | LGY42548 | 256,-  |
| ● Bianco G68   | LGY42568 | 256,-  |
| ● Espresso G78 | LGY42578 | 256,-  |

| KLASISKS            | Modelis  | Cena € |
|---------------------|----------|--------|
| ● Avena G51         | LGY42551 | 256,-  |
| ● Antracite G59     | LGY42559 | 256,-  |
| ● Bianco Antico G62 | LGY42562 | 256,-  |

## EASY 325



Bianco  
G68

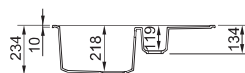
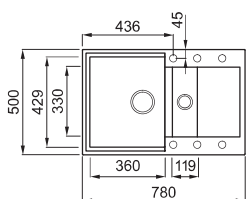

Izmērs (mm) **780 x 500**  
 Skapiša platums (mm) **600**  
 Izgriezums (mm) **760 x 480**  
 Bļodas 1 dziļums (mm) **220**  
 Bļodas 2 dziļums (mm) **120**  
 Montāžas veids **legriežama**

### IETEICAMIE PIEDERUMI

88 97 25 50 156 163 4 5 75 9

### MATERIĀLS UN KRĀSAS

**GRANITEK**  
NATURAL GRANITE EFFECT

|           |                     |          | Cena € |
|-----------|---------------------|----------|--------|
| METĀLISKS | ● Nero Metal M70    | LMY32570 | 272,-  |
|           | ● Titanium M73      | LMY32573 | 272,-  |
|           | ● Aluminium M79     | LMY32579 | 272,-  |
| MATĒTS    | ● Nero G40          | LGY32540 | 272,-  |
|           | ● Tortora G43       | LGY32543 | 272,-  |
|           | ● Cemento G48       | LGY32548 | 272,-  |
|           | ● Bianco G68        | LGY32568 | 272,-  |
|           | ● Espresso G78      | LGY32578 | 272,-  |
| KLASISKS  | ● Avena G51         | LGY32551 | 272,-  |
|           | ● Antracite G59     | LGY32559 | 272,-  |
|           | ● Bianco Antico G62 | LGY32562 | 272,-  |

## EASY 310



Bianco  
G68

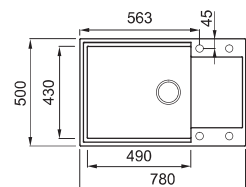

Izmērs (mm) **780 x 500**  
 Skapiša platums (mm) **600 ||| 800 ja pirmais skapis**  
 Izgriezums (mm) **760 x 480**  
 Bļodas dziļums (mm) **200**  
 Montāžas veids **legriežama**  
 Installation Position

### IETEICAMIE PIEDERUMI

88 97 25 50 156 163 4 5 75  
 71 9 194 194

### MATERIĀLS UN KRĀSAS

**GRANITEK**  
NATURAL GRANITE EFFECT

|           |                     |          | Cena € |
|-----------|---------------------|----------|--------|
| METĀLISKS | ● Nero Metal M70    | LMY31070 | 223,-  |
|           | ● Titanium M73      | LMY31073 | 223,-  |
|           | ● Aluminium M79     | LMY31079 | 223,-  |
| MATĒTS    | ● Nero G40          | LGY31040 | 223,-  |
|           | ● Tortora G43       | LGY31043 | 223,-  |
|           | ● Cemento G48       | LGY31048 | 223,-  |
|           | ● Bianco G68        | LGY31068 | 223,-  |
|           | ● Espresso G78      | LGY31078 | 223,-  |
| KLASISKS  | ● Avena G51         | LGY31051 | 223,-  |
|           | ● Antracite G59     | LGY31059 | 223,-  |
|           | ● Bianco Antico G62 | LGY31062 | 223,-  |



## EASY 300

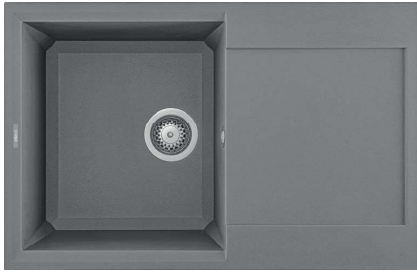

Titanium  
M73

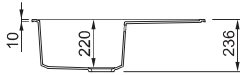
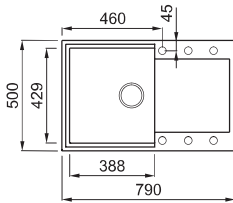

Izmērs (mm) **790 x 500**  
Skapiša platums (mm) **500 ||| 600 ja pirmais skapis**  
Izgriezums (mm) **770 x 480**  
Bļodas dziļums (mm) **220**  
Montāžas veids **legriežama**

### IETEICAMIE PIEDERUMI

|    |     |     |     |     |   |   |    |    |
|----|-----|-----|-----|-----|---|---|----|----|
| 88 | 25  | 50  | 156 | 163 | 4 | 5 | 75 | 71 |
| 9  | 194 | 195 |     |     |   |   |    |    |

### MATERIĀLS UN KRĀSAS

**GRANITEK**  
NATURAL GRANITE EFFECT

| METĀLISKS        |          |  | Cena € |
|------------------|----------|--|--------|
| ● Nero Metal M70 | LMY30070 |  | 223,-  |
| ● Titanium M73   | LMY30073 |  | 223,-  |
| ● Aluminium M79  | LMY30079 |  | 223,-  |

| MATĒTS         |          |  |       |
|----------------|----------|--|-------|
| ● Nero G40     | LGY30040 |  | 223,- |
| ● Tortora G43  | LGY30043 |  | 223,- |
| ● Cemento G48  | LGY30048 |  | 223,- |
| ● Bianco G68   | LGY30068 |  | 223,- |
| ● Espresso G78 | LGY30078 |  | 223,- |

| KLASISKS            |          |  |       |
|---------------------|----------|--|-------|
| ● Avena G51         | LGY30051 |  | 223,- |
| ● Antracite G59     | LGY30059 |  | 223,- |
| ● Bianco Antico G62 | LGY30062 |  | 223,- |

## EASY 290



Titanium  
M73

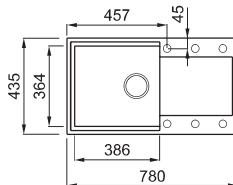

Izmērs (mm) **780 x 435**  
Skapiša platums (mm) **500 ||| 600 ja pirmais skapis**  
Izgriezums (mm) **760 x 415**  
Bļodas dziļums (mm) **210**  
Montāžas veids **legriežama**

### IETEICAMIE PIEDERUMI

|    |    |    |     |     |   |    |   |     |     |
|----|----|----|-----|-----|---|----|---|-----|-----|
| 97 | 25 | 50 | 157 | 163 | 5 | 71 | 9 | 194 | 195 |
|----|----|----|-----|-----|---|----|---|-----|-----|

### MATERIĀLS UN KRĀSAS

**GRANITEK**  
NATURAL GRANITE EFFECT

| METĀLISKS        |          |  | Cena € |
|------------------|----------|--|--------|
| ● Nero Metal M70 | LMY29070 |  | 247,-  |
| ● Titanium M73   | LMY29073 |  | 247,-  |
| ● Aluminium M79  | LMY29079 |  | 247,-  |

| MATĒTS         |          |  |       |
|----------------|----------|--|-------|
| ● Nero G40     | LGY29040 |  | 247,- |
| ● Tortora G43  | LGY29043 |  | 247,- |
| ● Cemento G48  | LGY29048 |  | 247,- |
| ● Bianco G68   | LGY29068 |  | 247,- |
| ● Espresso G78 | LGY30078 |  | 247,- |

| KLASISKS            |          |  |       |
|---------------------|----------|--|-------|
| ● Avena G51         | LGY30051 |  | 247,- |
| ● Antracite G59     | LGY30059 |  | 247,- |
| ● Bianco Antico G62 | LGY30062 |  | 247,- |

## EASY 150

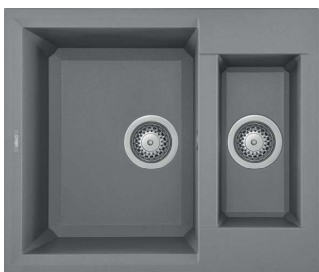

Titanium  
M73

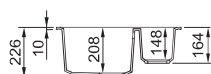
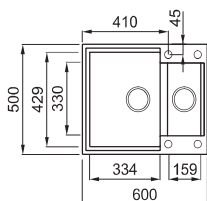

Izmērs (mm) **600 x 500**  
 Skapiša platums (mm) **600 ||| 800 ja pirmais skapis**  
 Izgriezums (mm) **580 x 480**  
 Bļodas 1 dziļums (mm) **210**  
 Bļodas 2 dziļums (mm) **150**  
 Montāžas veids **legriezama**

### IETEICAMIE PIEDERUMI

88 96 25 50 156 163 4 5 75 9

### MATERIĀLS UN KRĀSAS

**GRANITEK**  
NATURAL GRANITE EFFECT

|           |  |                            | Cena € |
|-----------|--|----------------------------|--------|
| METĀLISKS |  | Nero Metal M70 LMY15070    | 256,-  |
|           |  | Titanium M73 LMY15073      | 256,-  |
|           |  | Aluminium M79 LMY15079     | 256,-  |
| MATĒTS    |  | Nero G40 LGY15040          | 256,-  |
|           |  | Tortora G43 LGY15043       | 256,-  |
|           |  | Cemento G48 LGY15048       | 256,-  |
|           |  | Bianco G68 LGY15068        | 256,-  |
|           |  | Espresso G78 LGY15078      | 256,-  |
| KLASISKS  |  | Avena G51 LGY15051         | 256,-  |
|           |  | Antracite G59 LGY15059     | 256,-  |
|           |  | Bianco Antico G62 LGY15062 | 256,-  |

## EASY 135



Titanium  
M73

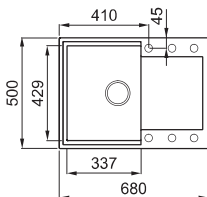

Izmērs (mm) **680 x 500**  
 Skapiša platums (mm) **450 ||| 600 ja pirmais skapis**  
 Izgriezums (mm) **660 x 480**  
 Bļodas dziļums (mm) **210**  
 Montāžas veids **legriezama**

### IETEICAMIE PIEDERUMI

88 97 25 50 163 4 5 75 71  
 9 194 195

### MATERIĀLS UN KRĀSAS

**GRANITEK**  
NATURAL GRANITE EFFECT

|           |  |                            | Cena € |
|-----------|--|----------------------------|--------|
| METĀLISKS |  | Nero Metal M70 LMY13570    | 207,-  |
|           |  | Titanium M73 LMY13573      | 207,-  |
|           |  | Aluminium M79 LMY13579     | 207,-  |
| MATĒTS    |  | Nero G40 LGY13540          | 207,-  |
|           |  | Tortora G43 LGY13543       | 207,-  |
|           |  | Cemento G48 LGY13548       | 207,-  |
|           |  | Bianco G68 LGY13568        | 207,-  |
|           |  | Espresso G78 LGY13578      | 207,-  |
| KLASISKS  |  | Avena G51 LGY13551         | 207,-  |
|           |  | Antracite G59 LGY13559     | 207,-  |
|           |  | Bianco Antico G62 LGY13562 | 207,-  |

## EASY CORNER



Aluminium  
M79

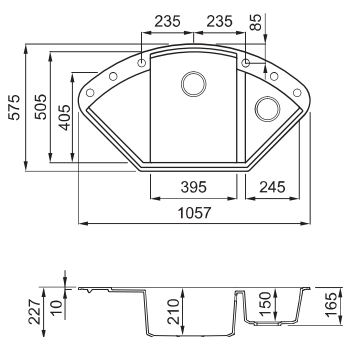

Izmērs (mm)  
Skapiša platums (mm)

**1057 x 575**  
Stūra skapis ||| 800  
|||1200 ja pirmais skapis  
pa kreisi || 800 ja pirmais  
skapis pa labi (minimālā  
darba virsma 650 mm)

Izgriezums (mm)  
Bļodas 1 dziļums (mm)  
Bļodas 2 dziļums (mm)  
Montāžas veids

Pēc šablona  
**210**  
**150**  
**iegriežama**

### IETEICAMIE PIEDERUMI

96 25 50 163 5 75 71 9

### MATERIĀLS UN KRĀSAS

**GRANITEK**  
NATURAL GRANITE EFFECT

| METĀLISKS        |          |  | Cena € |
|------------------|----------|--|--------|
| ● Nero Metal M70 | LMYCOR70 |  | 359,-  |
| ● Titanium M73   | LMYCOR73 |  | 359,-  |
| ● Aluminium M79  | LMYCOR79 |  | 359,-  |

| MATĒTS         |          |  |       |
|----------------|----------|--|-------|
| ● Nero G40     | LGYCOR40 |  | 359,- |
| ● Tortora G43  | LGYCOR43 |  | 359,- |
| ● Cemento G48  | LGYCOR48 |  | 359,- |
| ● Bianco G68   | LGYCOR68 |  | 359,- |
| ● Espresso G78 | LGYCOR78 |  | 359,- |

| KLASISKS            |          |  |       |
|---------------------|----------|--|-------|
| ● Avena G51         | LGYCOR51 |  | 359,- |
| ● Antracite G59     | LGYCOR59 |  | 359,- |
| ● Bianco Antico G62 | LGYCOR62 |  | 359,- |

\* Šablons iekļauts komplektā vai arī pieejams lejupielādei no vietnes [www.elleci.com/it](http://www.elleci.com/it) ipašās lejupielādes sadaļas

## EASY 600 ROUND



Aluminium  
M79

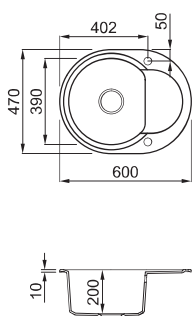

Izmērs (mm)  
Skapiša platums (mm)  
Izgriezums (mm)  
Bļodas dziļums (mm)  
Montāžas veids

**600 x 470**  
**450**  
**Pēc šablona**  
**200**  
**iegriežama**

### IETEICAMIE PIEDERUMI

97 163 15

### MATERIĀLS UN KRĀSAS

**GRANITEK**  
NATURAL GRANITE EFFECT

| METĀLISKS        |          |  | Cena € |
|------------------|----------|--|--------|
| ● Nero Metal M70 | LMYR6070 |  | 210,-  |
| ● Titanium M73   | LMYR6073 |  | 210,-  |
| ● Aluminium M79  | LMYR6079 |  | 210,-  |

| MATĒTS         |          |  |       |
|----------------|----------|--|-------|
| ● Nero G40     | LGYR6040 |  | 210,- |
| ● Tortora G43  | LGYR6043 |  | 210,- |
| ● Cemento G48  | LGYR6048 |  | 210,- |
| ● Bianco G68   | LGYR6068 |  | 210,- |
| ● Espresso G78 | LGYR6078 |  | 210,- |

| KLASISKS            |          |  |       |
|---------------------|----------|--|-------|
| ● Avena G51         | LGYR6051 |  | 210,- |
| ● Antracite G59     | LGYR6059 |  | 210,- |
| ● Bianco Antico G62 | LGYR6062 |  | 210,- |

\* Šablons iekļauts komplektā vai arī pieejams lejupielādei no vietnes [www.elleci.com/it](http://www.elleci.com/it) ipašās lejupielādes sadaļas

KOLEKCIJA  
**LIFE**



PAPILDUS  
INFORMĀCIJA  
LIFE



**IKDIENA**

Klasika satiekas ar moderno, izmantojot diskrētas, maigas un būtiskas formas un līnijas. Estētika koncentrējas uz tās būtību, konkrētu un svarīgu funkcionalitāti ikdienas lietošanā.

PLUS **LIFE**



ELEMENT  
PIEDERUMI



BLODA AR  
NŌAPALOTIEM  
STŪRIEM



IPAŠS  
DIZAINS

**GRANITEK**<sup>®</sup>  
NATURAL GRANITE EFFECT

● **Nero Metal**  
M70

● **Titanium**  
M73

● **Aluminium**  
M79

● **Nero**  
G40

● **Tortora**  
G43

● **Cemento**  
G48

○ **Bianco**  
G68

● **Espresso**  
G78

● **Avena**  
G51

● **Antracite**  
G59

● **Bianco Antico**  
G62

## MODELIS LIFE

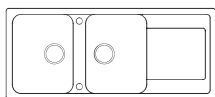

LIFE 500

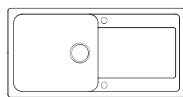

LIFE 480

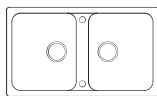

LIFE 450

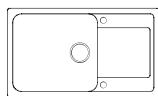

LIFE 410

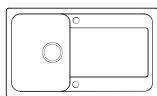

LIFE 400

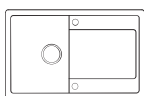

LIFE 300

**Komplektā:** Vietu taupošs sifons, ventiļu sistēma ar apaļu pārplūdi un montāžas āķi.

## IETEICAMIE PIEDERUMI

88

**50 cm GRIEŽAMĀIS  
DĒLIS  
ELEMENT  
ATH010BK**  
108.Lpp.



**Apdare**



Melns Pelēks Ozols Goba

71

**IZLIETNES PAMATNES  
METĀLA REŽĢIS**  
AGB01306  
116.Lpp.



## PERFEKTI SADERĪGS ŪDENS MAISĪTĀJS



**TRAIL PLUS – Hromēts CR**  
MIKTRPCR

125.Lpp.

Pieejamās krāsas



## PAPILDUS



**ELEMENT KOMPLEKTS  
VADĪBAS KONTROLE ATVER  
PAGRIEŽOT OPEN-TWIST ELEMENT**  
Art. KITASP-FB-IVTELL-IN

114. Lpp.

## elleci | BEAUTY



Produktu linija, kas īpaši izstrādāta kompozitmateriālu izlietņu kopšanai.

Vairāk informācijas **140.**lpp.

\*Lai iegūtu plašāku informāciju, skatiet piederumu sadaļu **106.** lappusē

## LIFE 500 JAUNS



Bianco  
G68

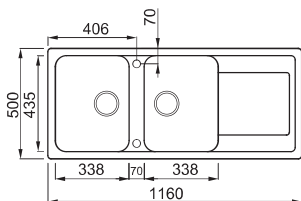

Izmērs (mm) **1160 x 500**  
 Skapiša platums (mm) **800 ||| 900 ja pirmais skapis**  
 Izgriezums (mm) **1140 x 480**  
 Bļodas 1 dziļums (mm) **180**  
 Bļodas 2 dziļums (mm) **180**  
 Montāžas veids **legriežama**

### IETEICAMIE PIEDERUMI

59 38 78 102 66 82 119 40 134

### MATERIĀLS UN KRĀSAS

**GRANITEK**  
NATURAL GRANITE EFFECT

METĀLISKS

|                  |          | Cena € |
|------------------|----------|--------|
| ● Nero Metal M70 | LM250070 | 275,-  |
| ● Titanium M73   | LM250073 | 275,-  |
| ● Aluminium M79  | LM250079 | 275,-  |

MATĒTS

|                |          |       |
|----------------|----------|-------|
| ● Nero G40     | LG250040 | 275,- |
| ● Tortora G43  | LG250043 | 275,- |
| ● Cemento G48  | LG250048 | 275,- |
| ● Bianco G68   | LG250068 | 275,- |
| ● Espresso G78 | LG250078 | 275,- |

KLASISKS

|                     |          |       |
|---------------------|----------|-------|
| ● Avena G51         | LG250051 | 275,- |
| ● Antracite G59     | LG250059 | 275,- |
| ● Bianco Antico G62 | LG250062 | 275,- |

## LIFE 480 JAUNS



Bianco  
G68

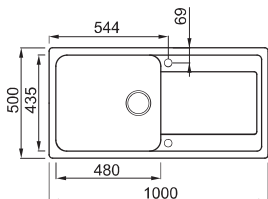

Izmērs (mm) **1000 x 500**  
 Skapiša platums (mm) **600**  
 Izgriezums (mm) **980 x 480**  
 Bļodas dziļums (mm) **180**  
 Montāžas veids **legriežama**

### IETEICAMIE PIEDERUMI

59 43 49 41 78 102 66 82 119  
 27 134 194 195

### MATERIĀLS UN KRĀSAS

**GRANITEK**  
NATURAL GRANITE EFFECT

METĀLISKS

|                  |          | Cena € |
|------------------|----------|--------|
| ● Nero Metal M70 | LM248070 | 261,-  |
| ● Titanium M73   | LM248073 | 261,-  |
| ● Aluminium M79  | LM248079 | 261,-  |

MATĒTS

|                |          |       |
|----------------|----------|-------|
| ● Nero G40     | LG248040 | 261,- |
| ● Tortora G43  | LG248043 | 261,- |
| ● Cemento G48  | LG248048 | 261,- |
| ● Bianco G68   | LG248068 | 261,- |
| ● Espresso G78 | LG248078 | 261,- |

KLASISKS

|                     |          |       |
|---------------------|----------|-------|
| ● Avena G51         | LG248051 | 261,- |
| ● Antracite G59     | LG248059 | 261,- |
| ● Bianco Antico G62 | LG248062 | 261,- |

## elleci | VIRTUVE

### LIFE 410 JAUNS



Cemento  
G48

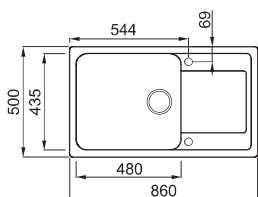

Izmērs (mm) **860 x 500**  
 Skapiša platums (mm) **600**  
 Izgriezums (mm) **840 x 480**  
 Bļodas dziļums (mm) **180**  
 Montāžas veids **legriežama**



#### IETEICAMIE PIEDERUMI

|    |     |     |     |    |     |    |    |     |
|----|-----|-----|-----|----|-----|----|----|-----|
| 59 | 43  | 49  | 41  | 78 | 102 | 66 | 82 | 119 |
| 27 | 134 | 194 | 195 |    |     |    |    |     |

#### MATERIĀLS UN KRĀSAS

**GRANITEK**  
NATURAL GRANITE EFFECT

| METĀLISKS |                          |          | Cena €       |
|-----------|--------------------------|----------|--------------|
| ●         | <b>Nero Metal</b><br>M70 | LM241070 | <b>236,-</b> |
| ●         | <b>Titanium</b><br>M73   | LM241073 | <b>236,-</b> |
| ●         | <b>Aluminium</b><br>M79  | LM241079 | <b>236,-</b> |

| MATĒTS |                        |          |              |
|--------|------------------------|----------|--------------|
| ●      | <b>Nero</b><br>G40     | LG241040 | <b>236,-</b> |
| ●      | <b>Tortora</b><br>G43  | LG241043 | <b>236,-</b> |
| ●      | <b>Cemento</b><br>G48  | LG241048 | <b>236,-</b> |
| ○      | <b>Bianco</b><br>G68   | LG241068 | <b>236,-</b> |
| ●      | <b>Espresso</b><br>G78 | LG241078 | <b>236,-</b> |

| KLASISKS |                             |          |              |
|----------|-----------------------------|----------|--------------|
| ●        | <b>Avena</b><br>G51         | LG241051 | <b>236,-</b> |
| ●        | <b>Antracite</b><br>G59     | LG241059 | <b>236,-</b> |
| ●        | <b>Bianco Antico</b><br>G62 | LG241062 | <b>236,-</b> |

### LIFE 400 JAUNS



Cemento  
G48

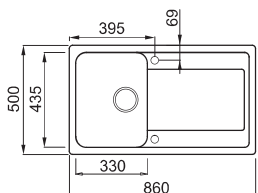

Izmērs (mm) **860 x 500**  
 Skapiša platums (mm) **450**  
 Izgriezums (mm) **840 x 480**  
 Bļodas dziļums (mm) **180**  
 Montāžas veids **legriežama**



#### IETEICAMIE PIEDERUMI

|    |    |     |    |    |     |    |     |     |     |
|----|----|-----|----|----|-----|----|-----|-----|-----|
| 59 | 43 | 102 | 66 | 82 | 119 | 40 | 134 | 194 | 195 |
|----|----|-----|----|----|-----|----|-----|-----|-----|

#### MATERIĀLS UN KRĀSAS

**GRANITEK**  
NATURAL GRANITE EFFECT

| METĀLISKS |                          |          | Cena €       |
|-----------|--------------------------|----------|--------------|
| ●         | <b>Nero Metal</b><br>M70 | LM240070 | <b>224,-</b> |
| ●         | <b>Titanium</b><br>M73   | LM240073 | <b>224,-</b> |
| ●         | <b>Aluminium</b><br>M79  | LM240079 | <b>224,-</b> |

| MATĒTS |                        |          |              |
|--------|------------------------|----------|--------------|
| ●      | <b>Nero</b><br>G40     | LG240040 | <b>224,-</b> |
| ●      | <b>Tortora</b><br>G43  | LG240043 | <b>224,-</b> |
| ●      | <b>Cemento</b><br>G48  | LG240048 | <b>224,-</b> |
| ○      | <b>Bianco</b><br>G68   | LG240068 | <b>224,-</b> |
| ●      | <b>Espresso</b><br>G78 | LG240078 | <b>224,-</b> |

| KLASISKS |                             |          |              |
|----------|-----------------------------|----------|--------------|
| ●        | <b>Avena</b><br>G51         | LG240051 | <b>224,-</b> |
| ●        | <b>Antracite</b><br>G59     | LG240059 | <b>224,-</b> |
| ●        | <b>Bianco Antico</b><br>G62 | LG240062 | <b>224,-</b> |

## LIFE 300 JAUNS



Tortora  
G43

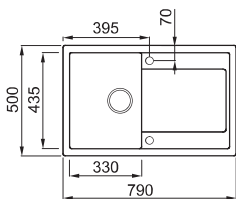

Izmērs (mm) **790 x 500**  
 Skapiša platums (mm) **450**  
 Izgriezums (mm) **770 x 480**  
 Bļodas dziļums (mm) **180**  
 Montāžas veids **legriežama**



### IETEICAMIE PIEDERUMI

|    |     |     |     |    |     |    |    |     |
|----|-----|-----|-----|----|-----|----|----|-----|
| 59 | 43  | 49  | 41  | 78 | 102 | 66 | 82 | 119 |
| 27 | 134 | 194 | 195 |    |     |    |    |     |

### MATERIĀLS UN KRĀSAS

**GRANITEK**  
NATURAL GRANITE EFFECT

|           |                   |          | Cena € |
|-----------|-------------------|----------|--------|
| METĀLISKS | Nero Metal M70    | LM230070 | 214,-  |
|           | Titanium M73      | LM230073 | 214,-  |
|           | Aluminium M79     | LM230079 | 214,-  |
| MATĒTS    | Nero G40          | LG230040 | 214,-  |
|           | Tortora G43       | LG230043 | 214,-  |
|           | Cemento G48       | LG230048 | 214,-  |
|           | Bianco G68        | LG230068 | 214,-  |
|           | Espresso G78      | LG230078 | 214,-  |
| KLASISKS  | Avena G51         | LG230051 | 214,-  |
|           | Antracite G59     | LG230059 | 214,-  |
|           | Bianco Antico G62 | LG230062 | 214,-  |

## LIFE 450 JAUNS



Tortora  
G43

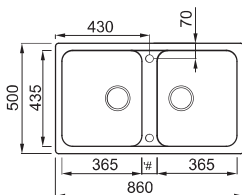

Izmērs (mm) **860 x 500**  
 Skapiša platums (mm) **900**  
 Izgriezums (mm) **840 x 480**  
 Bļodas 1 dziļums (mm) **180**  
 Bļodas 2 dziļums (mm) **180**  
 Montāžas veids **legriežama**



### IETEICAMIE PIEDERUMI

|   |    |    |     |    |   |     |    |     |
|---|----|----|-----|----|---|-----|----|-----|
| 8 | 38 | 78 | 102 | 21 | 8 | 119 | 40 | 134 |
|---|----|----|-----|----|---|-----|----|-----|

### MATERIĀLS UN KRĀSAS

**GRANITEK**  
NATURAL GRANITE EFFECT

|           |                   |          | Cena € |
|-----------|-------------------|----------|--------|
| METĀLISKS | Nero Metal M70    | LM245070 | 249,-  |
|           | Titanium M73      | LM245073 | 249,-  |
|           | Aluminium M79     | LM245079 | 249,-  |
| MATĒTS    | Nero G40          | LG245040 | 249,-  |
|           | Tortora G43       | LG245043 | 249,-  |
|           | Cemento G48       | LG245048 | 249,-  |
|           | Bianco G68        | LG245068 | 249,-  |
|           | Espresso G78      | LG245078 | 249,-  |
| KLASISKS  | Avena G51         | LG245051 | 249,-  |
|           | Antracite G59     | LG245059 | 249,-  |
|           | Bianco Antico G62 | LG245062 | 249,-  |





Izlietne Life 480 Espresso G78 | Maisītājs TRAIL Hromēts

# PIEDERUMU KOLEKCIJA



## IDEĀLS SABIEDROTAIS KATRU BRĪDI

Elleci aksesuāri: ideāli sabiedrotie virtuvē, optimizējot telpu un izmantojot tehniskos un funkcionālos risinājumus sagatavošanas zonā var piešķirt atšķirīgu pieskārienu un raksturu, kas padarīs jūsu virtuvi unikālu.

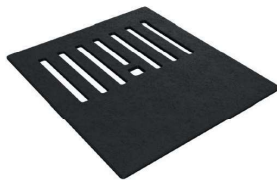

### BEST griežamais dēlis ELEMENT

Īpašs griešanas dēlis ar dizainu, kas to pārvērš par daudzfunkcionālu, telpu taupošu sistēmu, jo to var izmantot gan uz izlietnes malas, gan bļodas iekšpusē.

- MELNS
- PELĒKS,
- KOKA
- OZOLS
- GOBA



### BEST caurduris ELEMENT

Ideāls aksesuārs skalošanai un notecināšanai.



- MELNS
- HROMĒTS

**ZIEPJU DOZATORS  
ELEMENT**

Ērts integrēts aksesuārs, kas nerada papildu vietu izlietnē.



**FLEX 500 LOKANAIS PAKLĀJS**

Daudzpusīgs lietošanā, šis piederums ir ļoti ērts gan kā trauku nosusinātājs (novietojams virs izlietnes), gan arī kā paklājiņš novietots uz virtuves darba virsmas.



- MELNS
- TĒRAUDA
- ZELTA KRĀSA

**FLOW-PRO OPEN UP  
ELEMENT KOMPLEKTS**

Vienkāršs, bet elegants dizains. Ērtā lietošana padara to par modernu un piemērotu komplektu katram stilam.

193 SPAZIO GRIEŽAMĀIS DĒĻIS ELEMENT

Daudzfunkcionāls HPL griežamais dēlis

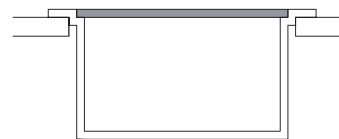
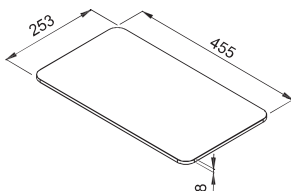

**APDARE** **Cena €**

- Melns**  
ATH123BK 93,-
- Koka**  
ATH123WD 93,-

**PIEMĒROTS**

SPAZIO



88 BĪDĀMS 50 GRIEŽAMĀIS DĒĻIS ELEMENT

Daudzfunkcionāls HPL griežamais dēlis

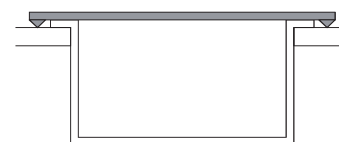
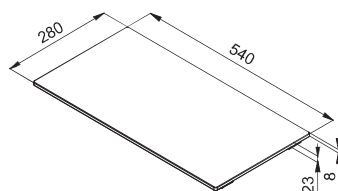

**APDARE** **Cena €**

- Melns**  
ATH010BK 127,-
- Pelēks**  
ATH010GR 127,-
- Ozols**  
ATH010QU 127,-
- Goba**  
ATH010OL 127,-

**PIEMĒROTS**

UNICO  
KARISMA  
EGO  
EASY



89 BEST GRIEŽAMĀIS DĒĻIS ELEMENT

Daudzfunkcionāls HPL griežamais dēlis

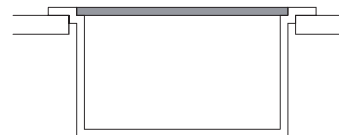
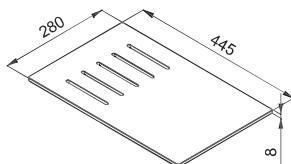

**APDARE** **Cena €**

- Melns**  
ATH020BK 106,-
- Pelēks**  
ATH020GR 106,-
- Ozols**  
ATH020QU 106,-
- Goba**  
ATH020OL 106,-

**PIEMĒROTS**

BEST



91 420 GRIEŽAMĀIS DĒĻIS ELEMENT

Daudzfunkcionāls HPL griežamais dēlis

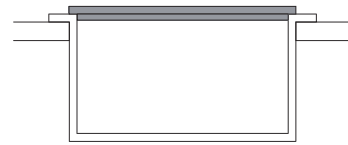
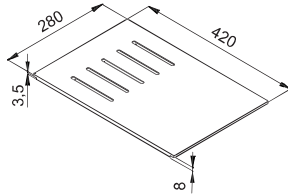

**APDARE** **Cena €**

|          |          |       |
|----------|----------|-------|
| ● Melns  | ATH040BK | 106,- |
| ● Pelēks | ATH040GR | 106,- |
| ● Ozols  | ATH040QU | 106,- |
| ● Goba   | ATH040OL | 106,- |
| ● Koka   | ATH040WD | 106,- |

**PIEMĒROTS**

ZEN  
ZEN-F  
QUADRA  
INTEGRA



155 FOX 360 GRIEŽAMĀIS DĒĻIS ELEMENT

Daudzfunkcionāls HPL griežamais dēlis

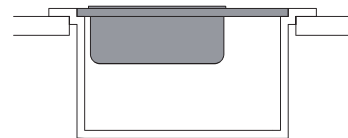
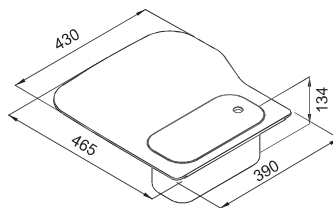

**APDARE** **Cena €**

|         |          |       |
|---------|----------|-------|
| ● Ozols | ATH130QU | 156,- |
| ● Goba  | ATH130OL | 156,- |

**PIEMĒROTS**

FOX



93 BEST DARBA STACIJA GRIEŽAMĀIS DĒĻIS ELEMENT

Daudzfunkcionāls HPL griežamais dēlis

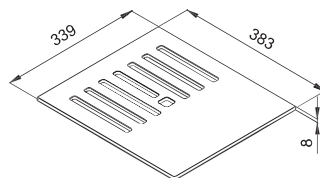

**APDARE** **Cena €**

|          |          |       |
|----------|----------|-------|
| ● Melns  | ATH073BK | 110,- |
| ● Pelēks | ATH073GR | 110,- |
| ● Ozols  | ATH073QU | 110,- |
| ● Goba   | ATH073OL | 110,- |
| ● Koka   | ATH073WD | 110,- |

**PIEMĒROTS**

BEST DARBA STACIJA  
BEST-F DARBA STACIJA



PIEDERUMI

157 FLEX 400 LOKANAIS PAKLĀJS ELEMENT

Silikona lokanaiss paklājs

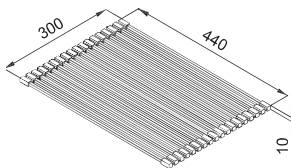

**APDARE** **Cena €**

● **Melns**  
ARS013BK **71,-**

**PIEMĒROTS**

GLOBE  
ZEN  
ZEN-F  
QUADRA  
QUADRA PABŪVĒJAMA  
KARISMA  
INTEGRA  
EASY



156 FLEX 500 LOKANAIS PAKLĀJS ELEMENT

Silikona lokanaiss paklājs

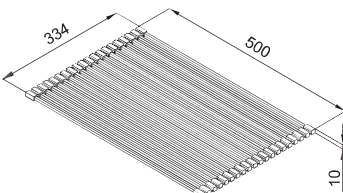

**APDARE** **Cena €**

● **Melns**  
ARS023BK **79,-**

**PIEMĒROTS**

UNICO  
BEST  
BEST DARBA STACIJA  
BEST-F DARBA STACIJA  
QUADRA  
QUADRA PABŪVĒJAMA  
EGO  
EASY

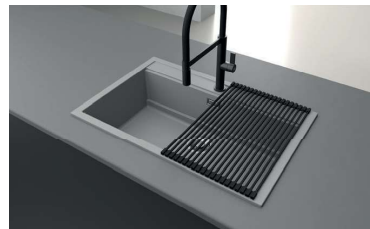

153 BEST DARBA STACIJA CAURDURIS ELEMENT

Plastikāta caurduris

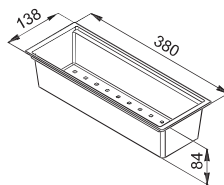

**APDARE** **Cena €**

● **Melns**  
AVP034BK **56,-**

**PIEMĒROTS**

BEST DARBA STACIJA  
BEST-F DARBA STACIJA



152 418 CAURDURIS ELEMENT

Plastikāta caurduris

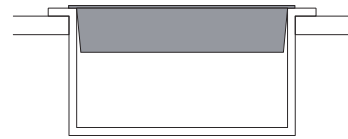
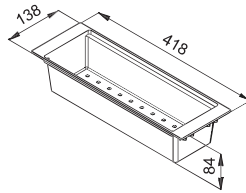

| APDARE              | Cena € |
|---------------------|--------|
| ● Melns<br>AVP035BK | 56,-   |

| PIEMĒROTS  |
|--|
| ZEN<br>ZEN-F<br>QUADRA<br>QUADRA PABŪVĒJAMA<br>INTEGRA |



25 APAĻŠ ZIEPJU DOZATORS ELEMENT

Ziepju dozators

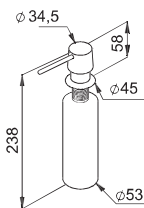

| APDARE                | Cena € |
|-----------------------|--------|
| ● Hromēts<br>ADI02300 | 37,-   |
| ● Melns<br>ADI02300BK | 56,-   |

| PIEMĒROTS  |
|--|
| UNICO<br>BEST DARBA STACIJA<br>BEST-F DARBA STACIJA<br>QUADRA<br>QUADRA PABŪVĒJAMA<br>EASY |



50 KANTAINS ZIEPJU DOZATORS ELEMENT

Ziepju dozators

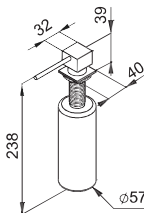

| APDARE                | Cena € |
|-----------------------|--------|
| ● Hromēts<br>ADI02301 | 88,-   |

| PIEMĒROTS  |
|--|
| UNICO<br>BEST DARBA STACIJA<br>BEST-F DARBA STACIJA<br>QUADRA<br>QUADRA PABŪVĒJAMA<br>UNICO<br>KARISMA<br>EASY |



PIEDERUMI

## 163 KOMPOZĪTMATERIĀLA DEKORATĪVAIS VENTĪĻA NOSEGS

Kompozītmateriāla vāciņš

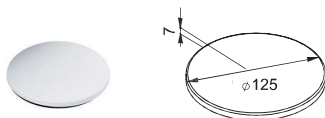

### PIEMĒROTS

ZEN  
UNICO  
QUADRA  
QUADRA PABŪVĒJAMA  
INTEGRA  
EGO  
EASY  
BEST  
BEST DARBA STACIJA



| APDARE                        | Cena € |                              | Cena € |
|-------------------------------|--------|------------------------------|--------|
| <b>Black</b><br>AKCP1286      | 37,-   | <b>Dark Grey</b><br>AKCP1299 | 37,-   |
| <b>Dove Grey</b><br>AKCP1293  | 37,-   | <b>Nero</b><br>AGCPI240      | 37,-   |
| <b>Champagne</b><br>AKCP1295  | 37,-   | <b>Tortora</b><br>AGCPI243   | 37,-   |
| <b>White</b><br>AKCP1296      | 37,-   | <b>Cemento</b><br>AGCPI248   | 37,-   |
| <b>Light Grey</b><br>AKCP1297 | 37,-   | <b>Bianco</b><br>AGCPI268    | 37,-   |



## 88 VENTĪĻIS AR PĀRPLŪDI

Ventīļa komplekts ar pārplūdi

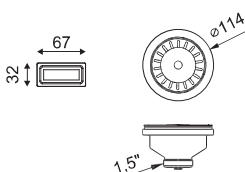

### APDARE

**Melnš**  
COMPP90CTPLUXABK 64,-

### PIEMĒROTS

ZEN  
INTEGRA  
BEST  
BEST DARBA STACIJA



## 164 FLOW-PRO UN PĀRPLŪDE ELEMENT

FLOW-PRO komplekts ar plārplūdi

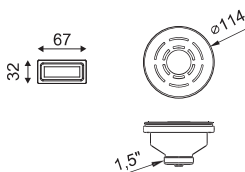

### APDARE

**Melnš Matēts**  
KITWPT-F-1VSELL-BK 96,-  
 **Zelta krāsa**  
KITWPT-F-1VSELL-GD 79,-

### PIEMĒROTS

SPAZIO  
BEST DARBA STACIJA  
ZEN  
ZEN-F  
INTEGRA  
BEST





100 SPIEDPOGA **ELEMENT**

FLOW-PRO ventiļu sistēma ar vadības pogu

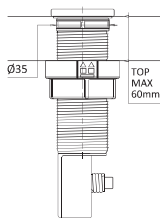

**APDARE** **Cena €**

|  |              |
|--|--------------|
|  Nerūsējoša tērauda<br>ASP13004 | <b>55,-</b>  |
|  Zelta krāsa<br>ASP13004GD      | <b>122,-</b> |
|  Melns<br>ASP13004BK            | <b>122,-</b> |

**PIEMĒROTS**

SPAZIO  
BEST DARBA STACIJA  
ZEN  
ZEN-F  
INTEGRA  
BEST



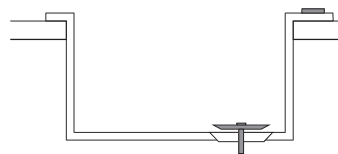
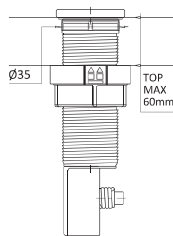

97 SPIEDPOGA **POP-UP ELEMENT**

Ventiļu sistēma ar vadības pogu



**APDARE** **Cena €**

|   |             |
|---|-------------|
|  Hromēts<br>ASP13002 | <b>32,-</b> |
|  Melns<br>ASP13002BK | <b>59,-</b> |

**PIEMĒROTS**

UNICO  
QUADRA  
EGO  
EASY  
BEST  
BEST DARBA STACIJA



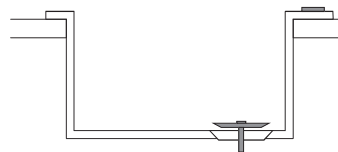
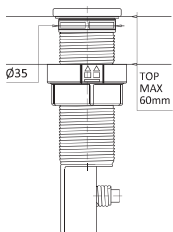

96 2-WAY SPIEDPOGA **POP-UP ELEMENT**

Ventiļu sistēma 2 bļodām ar vadības pogu



**APDARE** **Cena €**

|   |              |
|---|--------------|
|  Hromēts<br>ASP23002 | <b>62,-</b>  |
|  Melns<br>ASP23002BK | <b>112,-</b> |

**PIEMĒROTS**

UNICO  
QUADRA  
QUADRA PABŪVĒJAMA  
EGO  
EASY  
BEST



PIEDERUMI

## 97 SPIEDPOGA POP-UP ELEMENT

Ventiļu sistēma ar kantainu izvadu un vadības pogu

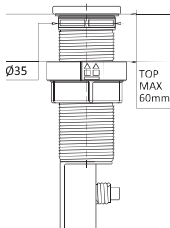

| APDARE   | Cena € |
|--|--------|
| <ul style="list-style-type: none"> <li><span style="display: inline-block; width: 10px; height: 10px; background-color: #ccc; border-radius: 50%; margin-right: 5px;"></span> <b>Hromēts</b></li> <li>KITWPT-FB-1VTELL-IN <b>52,-</b></li> </ul> |        |

**PIEMĒROTS**  
KARISMA



## 194 FLOW AR PLĀRPLŪDI ELEMENT

FLOW ventiļu sistēma ar pārplūdi

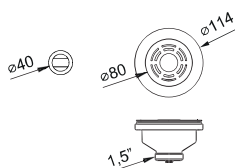

| APDARE   | Cena € |
|--|--------|
| <ul style="list-style-type: none"> <li><span style="display: inline-block; width: 10px; height: 10px; background-color: #ccc; border-radius: 50%; margin-right: 5px;"></span> <b>Hromēts</b></li> <li>KITWPT-FB-1VTELL-IN <b>23,-</b></li> <li><span style="display: inline-block; width: 10px; height: 10px; background-color: #000; border-radius: 50%; margin-right: 5px;"></span> <b>Melns</b></li> <li>KITWPT-FB-1VTELL-BK <b>28,-</b></li> </ul> |        |

**PIEMĒROTS**  
UNICO  
QUADRA  
EGO  
EASY  
LIFE



## 195 FLOW AR PAGRIEŽAMU POGU ELEMENT

Ventiļu sistēma ar vadības pogu

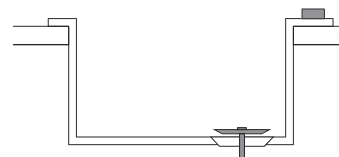
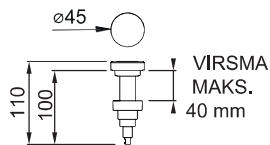

| APDARE   | Cena € |
|--|--------|
| <ul style="list-style-type: none"> <li><span style="display: inline-block; width: 10px; height: 10px; background-color: #ccc; border-radius: 50%; margin-right: 5px;"></span> <b>Hromēts</b></li> <li>KITASP-FB-1VTELL-IN <b>46,-</b></li> <li><span style="display: inline-block; width: 10px; height: 10px; background-color: #000; border-radius: 50%; margin-right: 5px;"></span> <b>Melns</b></li> <li>KITASP-FB-1VTELL-BK <b>50,-</b></li> </ul> |        |

**SADERĪGS**  
UNICO  
QUADRA  
EGO  
EASY  
LIFE





## GRIEŽAMIE DĒĻI

### 4 BĪDĀMS KOKA GRIEŽAMĀIS DĒĻIS



Cena € 87,-  
Izmērs (mm) 540 x 300  
Art.nr. ATL01000

### 10 EGO ROUND KOKA GRIEŽAMĀIS DĒĻIS



Cena € 82,-  
Izmērs (mm) Ø435  
Art.nr. ATL02300

## CAURDURI

### 5 CAURDURIS



Cena € 109,-  
Izmērs (mm) 322 x 195 x 95  
Art.nr. AVI03001

### 63 EASY CORNER CAURDURIS



Cena € 101,-  
Izmērs (mm) 400 x 284 x 8  
Art.nr. AVI03307

### 61 CAURDURIS STD L



Cena € 109,-  
Izmērs (mm) 462 x 134 x 72  
Art.nr. AVI03305

### 70 BEST CAURDURIS



Cena € 95,-  
Izmērs (mm) 444 x 142 x 103  
Art.nr. AVI03000

## IZLIETNES PAMATNES REŽĢI

### 43 PAMATNE

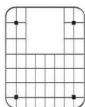

Cena € 65,-  
Izmērs (mm) 277 x 348  
Art.nr. AGB01300

### 67 PAMATNE M

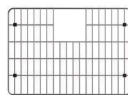

Cena € 92,-  
Izmērs (mm) 445 x 310  
Art.nr. AGB01304

### 68 PAMATNE L

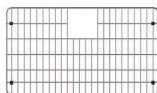

Cena € 92,-  
Izmērs (mm) 590 x 334  
Art.nr. AGB01303

### 71 PAMATNE S



Cena € 100,-  
Izmērs (mm) 285 x 300  
Art.nr. AGB01306

## GROZI

### 8 EGO ROUND GROZS



**Cena € 45,-**  
Izmērs (mm) Ø 345  
Art. nr. ACI02300

### 11 GROZS



**Cena € 90,-**  
Izmērs (mm) 405 x 312 x 195  
Art. nr. ACI03300

### 15 GROZS APAĻŠ



**Cena € 62,-**  
Izmērs (mm) Ø 320  
Art. nr. ACI02301

### 69 BEST GROZS



**Cena € 77,-**  
Izmērs (mm) 444 x 292 x 82  
Art. nr. ACI01306

### 30 GROZS



**Cena € 80,-**  
Izmērs (mm) 348 x 324 x 112  
Art. nr. ACI01304

### 75 GROZS



**Cena € 87,-**  
Izmērs (mm) 385 x 270 x 180  
Art. nr. ACI01307

PIEDERUMI

## CITI PIEDERUMI

### 9 TRAUKU ŽAVĒTĀJS



**Cena € 42,-**  
Izmērs (mm) 300 x 185 x 82  
Art. nr. ADI01300

### 48 PLASTIKĀTA CAURDURIS



**Cena € 19,-**  
Izmērs (mm) 270 x 137 x 60  
Art. nr. AVP01302

### 47 TĒRAUDA CAURDURIS



**Cena € 52,-**  
Izmērs (mm) 274 x 148 x 63  
Art. nr. AVI03002

## VIRTUVES ŪDENS MAISĪTĀJU KOLEKCIJA

Mūsu virtuves ūdens maisītāji ir izstrādāti tā, lai radītu īpašu telpu un apmierinātu visu veidu virtuves vajadzības, kas apvieno estētiku un funkcionalitāti.

Dizaina maisītāju linija ar dažādu apdari un stilu:

mūsdienīgi, ērti un tajā pašā laikā videi draudzīgi.



### VISS VIENĀ KRĀSĀ

Katra maisītāja detaļa un komponentes ir krāsotas izlietnes krāsā tā, lai tie būtu ideāli saskaņoti un radītu pilnīgu nepārtrauktības sajūtu

### APDARES

Eleganta un izsmalcināta apdare. Linija, kas izstrādāta, lai lieliski atbilstu mūsu izlietņu sastāvdaļām un ELLECI pasaulei.



### MELNS MATĒTS

Īpaša apdare, kas iemieso vienu no galvenajām dizaina tendencēm, kā arī lieliski iederas gandrīz jebkurā stilā, piedāvājot bezgalīgas pielāgošanās iespējas.

### EKO KĀRTRIDŽS

Tehnoloģija, kas piegādā tikai auksto ūdeni, kad svira ir sākumpozīcijā, tādā veidā ietaupot enerģiju arī saudzē vidi.

**PROFESIONĀLIE**

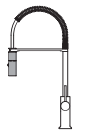

**ARCADIA**  
120.lpp.

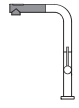

**FLUX**  
121.lpp.

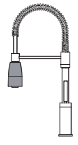

**CHEF**  
126.lpp.

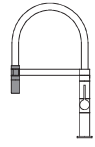

**WAVE**  
120.lpp.

**L FORMAS SNĪPIS**



**KENT**  
121.lpp.



**TEMA**  
126.lpp.



**ARES**  
123.lpp.



**STREAM PLUS**  
124.lpp.



**STREAM**  
124.lpp.

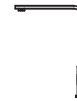

**IXORA**  
132.lpp.



**TRAIL PLUS**  
125.lpp.



**TRAIL**  
125.lpp.



**SHELL PLUS**  
131.lpp.



**SHELL**  
132.lpp.



**ALUNA PLUS**  
133.lpp.

**KOMBINĒTS AR  
FILTRA PIESLĒGUMU**



**TOURMALINE**  
122.lpp.

**APAĻAS FORMAS SNĪPIS**



**HYPE**  
123.lpp.



**ATHENA PLUS**  
127.lpp.



**DORA PLUS**  
128.lpp.

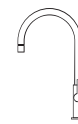

**VOLTA**  
130.lpp.



**CADDY**  
131.lpp.

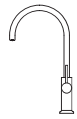

**CLUB**  
129.lpp.

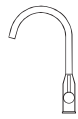

**ADIGE**  
128.lpp.



**ATHENA**  
127.lpp.



**BRIDGE**  
129.lpp.



**CLOUD**  
130.lpp.



**PO**  
135.lpp.

**TRADICIONĀLIE**



**RIO**  
137.lpp.



**RENO**  
134.lpp.



**DRIVE**  
133.lpp.



**SAVA**  
134.lpp.



**SENNA**  
135.lpp.



**VENERE**  
136.lpp.



**MINERVA**  
136.lpp.

**ŪDENS MAISĪTĀJU ĪPAŠĪBAS**



GROZĀMS SNĪPIS



IZVELKAMS UZGALIS



PĀRSLĒDZAMS  
STRŪKLAS REŽĪMS



AR FILTRA  
FUNKCIJU



PILNS KRĀSOJUMS



ENERGIJU TAUPOŠS  
KĀRTRIDŽS

## ŪDENS MAISĪTĀJI ARCADIA **JAUNS**



Vienas sviras ūdens maisītājs ar augstu grozāmu snipi un izvelkamu divu strūklu uzgali

### ĪPAŠĪBAS

Pamatne (mm) **47**  
Griešanās leņķis **360°**  
Lokanās caurules **Nerūsējošais tērauds 3/8"**  
Caurules garums **390 mm**  
Kārtridžs (ø mm) **25**  
Caurums montāžai (mm) **35**

**APDARE** Cena € **285,-**

 **Hromēts** MIKARCCR  
CR

**KRĀSA \*** Cena € **357,-**

 **Melns** MOKARCBK  
BK

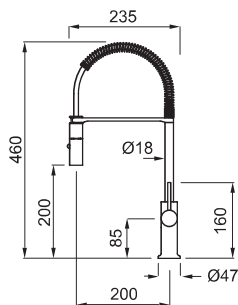

CR Hromēts

## WAVE



Vienas sviras ūdens maisītājs ar augstu lokanu silikona grozāmo snipi

### ĪPAŠĪBAS

Pamatne (mm) **50**  
Griešanās leņķis **360°**  
Lokanās caurules **Nerūsējošais tērauds 3/8"**  
Caurules garums **400 mm**  
Kārtridžs (ø mm) **25**  
Caurums montāžai (mm) **35**

**APDARE** Cena € **262,-**

 **Hromēts** MIKWAVCR  
CR

**Melns \*** Cena € **305,-**

 **Melns** MOKWAVBK  
BK

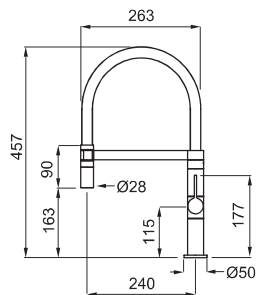

CR Hromēts

\* Krāsas, kas atbilst Keratek un Granitek materiāliem



**KENT** **JAUNS**



Vienas sviras ūdens maisītājs ar grozāmu snīpi un ar atsevišķu vadības sviru

**ĪPAŠĪBAS**

|                       |                                  |
|-----------------------|----------------------------------|
| Pamatne (mm)          | <b>46 (snīpis)</b>               |
|                       | <b>52 (vadībai)</b>              |
| Griešanās leņķis      | <b>360°</b>                      |
| Lokanās caurules      | <b>Nerūsējošais tērauds 3/8"</b> |
| Caurules garums       | <b>490 mm</b>                    |
| Kārtridžs (ø mm)      | <b>25</b>                        |
| Caurums montāžai (mm) | <b>35 (snīpis)</b>               |
|                       | <b>35 (vadībai)</b>              |

**APDARE** **Cena € 440,-**

● **Matēts hroms** MIKKENCS  
CS

● **Zelta krāsa** MOKKENG  
GD

**KRĀSA \*** **Cena € 383,-**

● **Melns** MOKKENBK  
BK

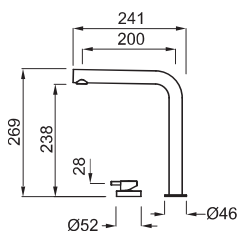

CS Matēts hroms

**FLUX**



Vienas sviras ūdens maisītājs ar grozāmu snīpi un izvelkamo divu strūklu uzgali

**ĪPAŠĪBAS**

|                       |                                  |
|-----------------------|----------------------------------|
| Pamatne (mm)          | <b>50</b>                        |
| Griešanās leņķis      | <b>360°</b>                      |
| Lokanās caurules      | <b>Nerūsējošais tērauds 3/8"</b> |
| Caurules garums       | <b>550 mm</b>                    |
| Kārtridžs (ø mm)      | <b>25</b>                        |
| Caurums montāžai (mm) | <b>35</b>                        |

**APDARE** **Cena € 368,-**

● **Hromēts** MIKFLUCR  
CR

**KRĀSA \*** **Cena € 387,-**

● **Melns** MOKFLUBK  
BK

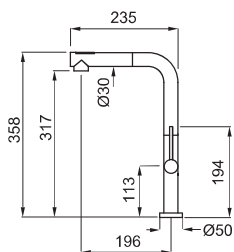

CR Hromēts

ŪDENS MAISĪTĀJI

\* Krāsas, kas atbilst Keratek un Granitek materiāliem

## ŪDENS MAISITĀJI TOURMALINE



Divu sviru ūdens maisītājs ar grozāmu snīpi, kas apvienots ar filtrētā ūdens padevi \*

### ĪPAŠĪBAS

|                       |                                |
|-----------------------|--------------------------------|
| Pamatne (mm)          | <b>50</b>                      |
| Griešanās leņķis      | <b>360°</b>                    |
| Lokanās caurules      | <b>Nerūsējošā tērauda 3/8"</b> |
| Caurules garums       | <b>400 mm</b>                  |
| Kārtridžs (ø mm)      | <b>35</b>                      |
| Caurums montāžai (mm) | <b>35</b>                      |

### APDARE **Cena € 224,-**

● **Nerūsējošais IN tērauds** MIKT011N

### KRĀSA **Cena € 254,-**

● **Black K86** MKKTOU86

○ **White K96** MKKTOU96

● **Nero G40** MGKT0140

○ **Bianco G68** MGKT0168

● **Avena G51** MGKT0151

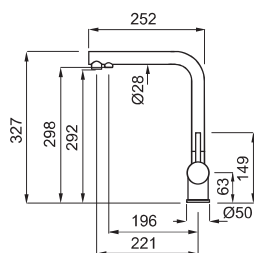

## FILTRĒŠANAS SISTĒMA

Elleci filtrēšanas sistēma pārveido jūsu ūdens maisītāju piekļūstot svaiguma avotam, attīrītam ūdenim. Maisītājs ar filtrēšanas sistēmu samazina smago metālu, hlora un kaļķakmens saturu krāna ūdenī un ir praktiski lietojams, jo filtrs ir savienots tieši ar ūdensvadu sistēmu un tādējādi nodrošina filtrētu ūdeni, kad vien tas ir nepieciešams.

Mainas filtra kapsula nodrošina 4000 litru kapacitāti (ieteicams nomainīt vismaz reizi gadā):

- Patēriņš līdz 4000 litriem / 6 mēneši



### PIEDERUMI



FILTRA KOMPLEKTS AR PIESLĒGUMU UN STIPRINĀJUMU

AFI01300

**Cena € 133,-**



MAIŅAS FILTRA KAPSULA

RFP01300 **Cena €**

**Cena € 69,-**

\* Filtra sistēma iegādājama atsevišķi

**HYPE** **JAUNS**



Vienas sviras ūdens maisītājs ar grozāmu snipi

**ĪPAŠĪBAS**

Pamatne (mm) **47**  
 Griešanās leņķis **360°**  
 Lokanās caurules **Nerūsējošais tērauds 3/8"**  
 Caurules garums **390 mm**  
 Kārtridžs (ø mm) **25**  
 Caurums montāžai (mm) **35**

**APDARE** **Cena € 309,-**

● **Matēts hroms** CS MIKHYP3S

**Cena € 309,-**

● **Zelta krāsa** GD MOKHYPGD

**KRĀSA \*** **Cena € 250,-**

● **Melns** BK MOKHYPBK

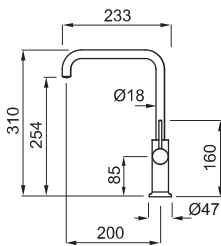

CS Matēts hroms

**ARES**



Vienas sviras ūdens maisītājs ar grozāmu snipi

**ĪPAŠĪBAS**

Pamatne (mm) **45**  
 Griešanās leņķis **360°**  
 Lokanās caurules **Nerūsējošais tērauds 3/8"**  
 Caurules garums **350 mm**  
 Kārtridžs (ø mm) **25**  
 Caurums montāžai (mm) **35**

**APDARE** **Cena € 233,-**

● **Hromēts** CR MIKARECR

**KRĀSA \*** **Cena € 257,-**

● **Black** K86 MKKARE86

● **White** K96 MKKARE96

● **Titanium** M73 MMKARE73

● **Aluminium** M79 MMKARE79

● **Nero** G40 MGKARE40

● **Tortora** G43 MGKARE43

● **Cemento** G48 MGKARE48

● **Bianco** G68 MGKARE68

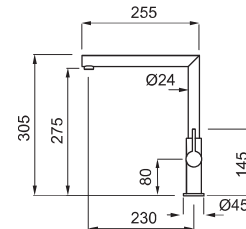

CS hromēts

ŪDENS MAISĪTĀJI

\* Krāsas, kas atbilst Keratek un Granitek materiāliem

## ŪDENS MAISĪTĀJI STREAM

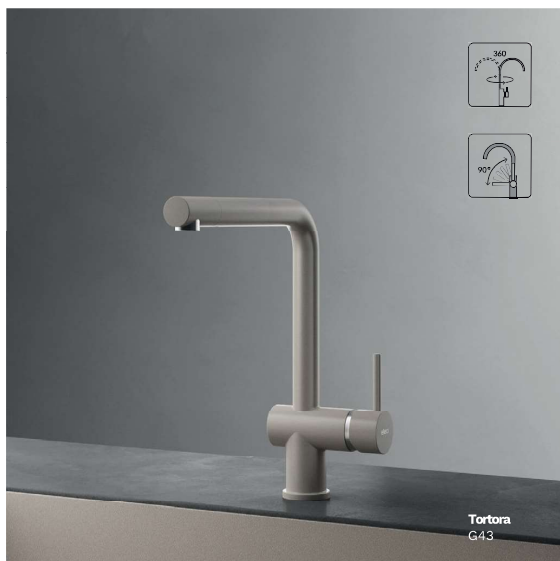

Vienas sviras ūdens maisītājs ar grozāmu snipi

### ĪPAŠĪBAS

|                       |                           |
|-----------------------|---------------------------|
| Pamatne (mm)          | 50                        |
| Griešanās leņķis      | 360°                      |
| Lokanās caurules      | Nerūsējošais tērauds 3/8" |
| Caurules garums       | 350 mm                    |
| Kārtridžs (ø mm)      | 35                        |
| Caurums montāžai (mm) | 35                        |

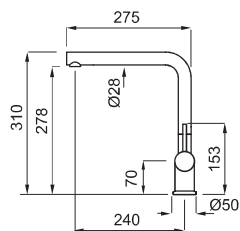

CR Hromēts

### APDARE Cena € 220,-

|            |          |
|------------|----------|
| Hromēts CR | MIKSTRCR |
|------------|----------|

### KRĀSA \* Cena € 257,-

|               |          |
|---------------|----------|
| Black K86     | MKKSTR86 |
| White K96     | MKKSTR96 |
| Dark Grey K99 | MKKSTR99 |
| Titanium M73  | MMKSTR73 |
| Aluminium M79 | MMKSTR79 |
| Nero G40      | MGKSTR40 |
| Tortora G43   | MGKSTR43 |
| Cemento G48   | MGKSTR48 |
| Bianco G68    | MGKSTR68 |
| Espresso G78  | MGKSTR78 |
| Avena G51     | MGKSTR51 |

## STREAM PLUS



Vienas sviras ūdens maisītājs ar grozāmu snipi un izvelkamu uzgali

### ĪPAŠĪBAS

|                       |                           |
|-----------------------|---------------------------|
| Pamatne (mm)          | 50                        |
| Griešanās leņķis      | 360°                      |
| Lokanās caurules      | Nerūsējošais tērauds 3/8" |
| Caurules garums       | 350 mm                    |
| Kārtridžs (ø mm)      | 35                        |
| Caurums montāžai (mm) | 35                        |

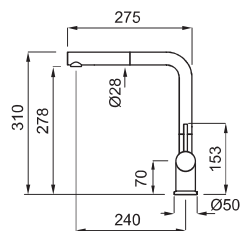

CR Hromēts

### APDARE Cena € 233,-

|            |          |
|------------|----------|
| Hromēts CR | MIKSTPCR |
|------------|----------|

### KRĀSA \* Cena € 269,-

|                |          |
|----------------|----------|
| Black K86      | MKKSTP86 |
| Dove Grey K93  | MKKSTP93 |
| Champagne K95  | MKKSTP95 |
| White K96      | MKKSTP96 |
| Light Grey K97 | MKKSTP97 |
| Dark Grey K99  | MKKSTP99 |
| Titanium M73   | MMKSTP73 |
| Aluminium M79  | MMKSTP79 |
| Nero G40       | MGKSTP40 |
| Tortora G43    | MGKSTP43 |
| Cemento G48    | MGKSTP48 |
| Bianco G68     | MGKSTP68 |
| Espresso G78   | MGKSTP78 |
| Avena G51      | MGKSTP51 |

\* Krāsas, kas atbilst Keratek un Granitek materiāliem

## TRAIL



Vienas sviras ūdens maisītājs ar grozāmu snipi

## TRAIL PLUS



Vienas sviras ūdens maisītājs ar grozāmu snipi un izvelkamu uzgali

### ĪPAŠĪBAS

Pamatne (mm) **50**  
Griešanās leņķis **360°**  
Lokanās caurules

**Nerūsējošais tērauds 3/8"**  
Caurules garums **350 mm**  
Kārtridzs (ø mm) **35**  
Caurums montāžai (mm) **35**

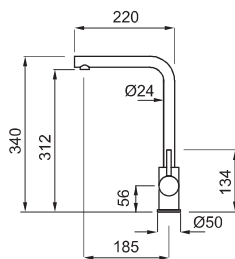

CR Hromēts

### APDARE Cena € 172,-

● Hromēts CR MIKTRACR

### KRĀSA \* Cena € 196,-

- Black K86 MKKTRA86
- Dove Grey K93 MKKTRA93
- Champagne K95 MKKTRA95
- White K96 MKKTRA96
- Light Grey K97 MKKTRA97
- Dark Grey K99 MKKTRA99
- Nero Metal M70 MMKTRA70
- Titanium M73 MMKTRA73
- Aluminium M79 MMKTRA79
- Nero G40 MGKTRA40
- Tortora G43 MGKTRA43
- Cemento G48 MGKTRA48
- Bianco G68 MGKTRA68
- Espresso G78 MGKTRA78
- Avena G51 MGKTRA51
- Antracite G59 MGKTRA59
- Bianco Antico G62 MGKTRA62

### ĪPAŠĪBAS

Pamatne (mm) **50**  
Griešanās leņķis **360°**  
Lokanās caurules **Nerūsējošais tērauds 3/8"**  
Caurules garums **400 mm**  
Kārtridzs (ø mm) **35**  
Caurums montāžai (mm) **35**

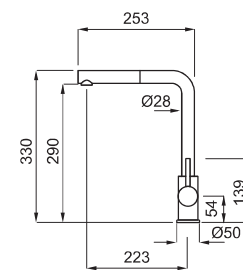

CR Hromēts

### APDARE Cena € 246,-

● Hromēts CR MIKTRPCR

### KRĀSA \* Cena € 266,-

- Black K86 MKKTRP86
- White K96 MKKTRP96
- Nero Metal M70 MMKTRP70
- Titanium M73 MMKTRP73
- Aluminium M79 MMKTRP79
- Nero G40 MGKTRP40
- Tortora G43 MGKTRP43
- Cemento G48 MGKTRP48
- Bianco G68 MGKTRP68
- Espresso G78 MGKTRP78
- Avena G51 MGKTRP51
- Antracite G59 MGKTRP59
- Bianco Antico G62 MGKTRP62

ŪDENS MAISĪTĀJI

\* Krāsas, kas atbilst Keratek un Granitek materiāliem

## ŪDENS MAISĪTĀJI CHEF



Vienas sviras ūdens maisītājs ar augstu grozāmu snīpi un divu strūklu uzgali

### ĪPAŠĪBAS

|                       |                                  |
|-----------------------|----------------------------------|
| Pamatne (mm)          | <b>50</b>                        |
| Griešanās leņķis      | <b>360°</b>                      |
| Lokanās caurules      | <b>Nerūsējošais tērauds 3/8"</b> |
| Caurules garums       | <b>350 mm</b>                    |
| Kārtridžs (ø mm)      | <b>35</b>                        |
| Caurums montāžai (mm) | <b>35</b>                        |

|                   |               |              |
|-------------------|---------------|--------------|
| <b>APDARE</b>     | <b>Cena €</b> | <b>295,-</b> |
| <b>Hromēts CR</b> |               | MIKCHECR     |

|                  |               |              |
|------------------|---------------|--------------|
| <b>KRĀSA *</b>   | <b>Cena €</b> | <b>331,-</b> |
| <b>Black K86</b> |               | MKKCHE86     |
| <b>Nero G40</b>  |               | MGKCHE40     |

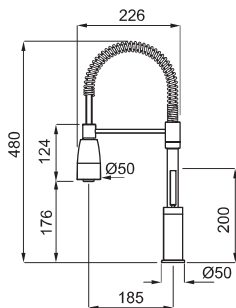

CR Hromēts

## TEMA



Vienas sviras ūdens maisītājs ar grozāmu snīpi

### ĪPAŠĪBAS

|                       |                                  |
|-----------------------|----------------------------------|
| Pamatne (mm)          | <b>50</b>                        |
| Griešanās leņķis      | <b>360°</b>                      |
| Lokanās caurules      | <b>Nerūsējošais tērauds 3/8"</b> |
| Caurules garums       | <b>700 mm</b>                    |
| Kārtridžs (ø mm)      | <b>25</b>                        |
| Caurums montāžai (mm) | <b>35</b>                        |

|                   |               |              |
|-------------------|---------------|--------------|
| <b>APDARE</b>     | <b>Cena €</b> | <b>431,-</b> |
| <b>Hromēts CR</b> |               | MIKTEMCR     |

|                       |               |              |
|-----------------------|---------------|--------------|
| <b>KRĀSA *</b>        | <b>Cena €</b> | <b>478,-</b> |
| <b>Black K86</b>      |               | MKKTEM86     |
| <b>Dove Grey K93</b>  |               | MKKTEM93     |
| <b>Champagne K95</b>  |               | MKKTEM95     |
| <b>White K96</b>      |               | MKKTEM96     |
| <b>Light Grey K97</b> |               | MKKTEM97     |
| <b>Dark Grey K99</b>  |               | MKKTEM99     |

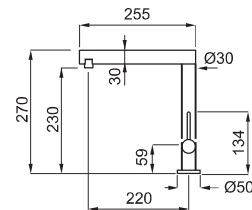

CR Hromēts

\* Krāsas, kas atbilst Keratek un Granitek materiāliem

## ATHENA



Vienas sviras ūdens maisītājs ar grozāmu snipi

### ĪPAŠĪBAS

Pamatne (mm) **48**  
 Griešanās leņķis **360°**  
 Lokanās caurules **Nerūsējošais tērauds 3/8"**  
 Caurules garums **500 mm**  
 Kārtridzs (ø mm) **25**  
 Caurums montāžai (mm) **35**

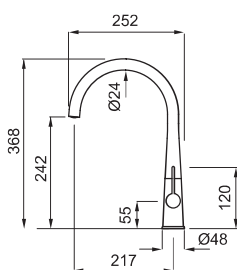

CR Hromēts

### APDARE Cena € 221,-

**Hromēts** MIKATHCR  
 CR

### KRĀSA \* Cena € 284,-

**Titanium** MMKATH73  
 M73  
**Aluminium** MMKATH79  
 M79  
**Nero** MGKATH40  
 G40  
**Tortora** MGKATH43  
 G43  
**Cemento** MGKATH48  
 G48  
**Bianco** MGKATH68  
 G68

elleci | VIRTUVE

## ATHENA PLUS

JAUNS



Vienas sviras ūdens maisītājs ar grozāmu snipi un izvelkamu uzgali

### ĪPAŠĪBAS

Pamatne (mm) **48**  
 Griešanās leņķis **360°**  
 Lokanās caurules **Nerūsējošais tērauds 3/8"**  
 Caurules garums **500 mm**  
 Kārtridzs (ø mm) **25**  
 Caurums montāžai (mm) **35**

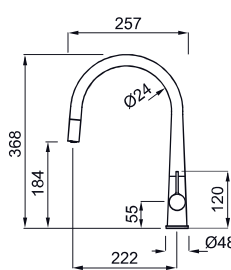

CR Hromēts

### APDARE Cena € 267,-

**Hromēts** MIKATPCR  
 CR

### KRĀSA \* Cena € 325,-

**Titanium** MMKATP73  
 M73  
**Aluminium** MMKATP79  
 M79  
**Nero** MGKATP40  
 G40  
**Tortora** MGKATP43  
 G43  
**Cemento** MGKATP48  
 G48  
**Bianco** MGKATP68  
 G68

ŪDENS MAISĪTĀJI

\*Krāsas, kas atbilst Keratek un Granitek materiāliem

## ŪDENS MAISĪTĀJI ADIGE



Vienas sviras ūdens maisītājs ar grozāmu snipi

### ĪPAŠĪBAS

|                       |                                  |
|-----------------------|----------------------------------|
| Pamatne (mm)          | <b>50</b>                        |
| Griešanās leņķis      | <b>360°</b>                      |
| Lokanās caurules      | <b>Nerūsējošais tērauds 3/8"</b> |
| Caurules garums       | <b>400 mm</b>                    |
| Kārtridžs (ø mm)      | <b>35</b>                        |
| Caurums montāžai (mm) | <b>35</b>                        |

### APDARE Cena € 184,-

● Nerūsējošais IN tērauds MIKADIIN

### KRĀSA \* Cena € 223,-

|              |          |
|--------------|----------|
| ● Black K86  | MKKADI86 |
| ● White K96  | MKKADI96 |
| ● Nero G40   | MGKADI40 |
| ● Bianco G68 | MGKADI68 |

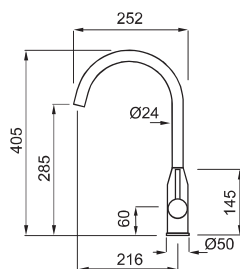

## DORA PLUS



Vienas sviras ūdens maisītājs ar grozāmu snipi un izvelkamu uzgali

### ĪPAŠĪBAS

|                       |                                  |
|-----------------------|----------------------------------|
| Pamatne (mm)          | <b>50</b>                        |
| Griešanās leņķis      | <b>360°</b>                      |
| Lokanās caurules      | <b>Nerūsējošais tērauds 3/8"</b> |
| Caurules garums       | <b>400 mm</b>                    |
| Kārtridžs (ø mm)      | <b>35</b>                        |
| Caurums montāžai (mm) | <b>35</b>                        |

### APDARE Cena € 221,-

● Nerūsējošais IN tērauds MIKDRPIN

### KRĀSA \* Cena € 263,-

|              |          |
|--------------|----------|
| ● Black K86  | MKKDRP86 |
| ● White K96  | MKKDRP96 |
| ● Nero G40   | MGKDRP40 |
| ● Bianco G68 | MGKDRP68 |

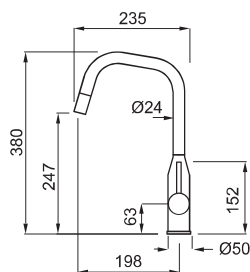

\* Krāsas, kas atbilst Keratek un Granitek materiāliem



**CLUB** **JAUNS**



ZELTA KRĀSA  
GD

Vienas sviras ūdens maisītājs ar grozāmu snipi

**BRIDGE**



Nero  
G40

Vienas sviras ūdens maisītājs ar grozāmu snipi

**ĪPAŠĪBAS**

Pamatne (mm) **47**  
Griešanās leņķis **360°**  
Lokanās caurules

**Nerūsējošais tērauds 3/8"**  
Caurules garums **390 mm**  
Kārtridžs (ø mm) **25**  
Caurums montāžai (mm) **35**

**APDARE** Cena € **309,-**

● **Matēts hroms** MIKCLUCS  
CS

Cena € **309,-**

● **Zelta krāsa** MOKCLUGD  
GD

**KRĀSA \*** Cena € **250,-**

● **Black** MOKCLUBK  
BK

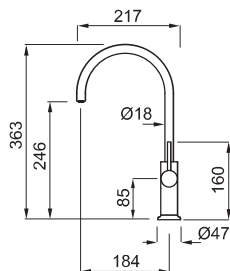

CS Matēts hroms

**ĪPAŠĪBAS**

Pamatne (mm) **50**  
Griešanās leņķis **360°**  
Lokanās caurules

**Nerūsējošais tērauds 3/8"**  
Caurules garums **350 mm**  
Kārtridžs (ø mm) **35**  
Caurums montāžai (mm) **35**

**APDARE** Cena € **172,-**

● **Hromēts** MIKBRICR  
CR

Cena € **172,-**

**KRĀSA \*** Cena € **226,-**

● **Black** MKKBRI86  
K86

● **White** MKKBRI96  
K96

● **Titanium** MMKBRI73  
M73

● **Aluminium** MMKBRI79  
M79

● **Nero** MGKBRI40  
G40

● **Tortora** MGKBRI43  
G43

● **Cemento** MGKBRI48  
G48

● **Bianco** MGKBRI68  
G68

● **Avena** MGKBRI51  
G51

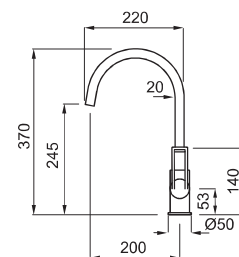

CR Hromēts

\* Krāsas, kas atbilst Keratek un Granitek materiāliem

ŪDENS MAISĪTĀJI

## ŪDENS MAISĪTĀJI VOLTA



Vienas sviras ūdens maisītājs ar grozāmu snipi

### ĪPAŠĪBAS

|                       |                           |
|-----------------------|---------------------------|
| Pamatne (mm)          | 45                        |
| Griešanās leņķis      | 360°                      |
| Lokanās caurules      | Nerūsējošais tērauds 3/8" |
| Caurules garums       | 350 mm                    |
| Kārtridžs (ø mm)      | 35                        |
| Caurums montāžai (mm) | 35                        |

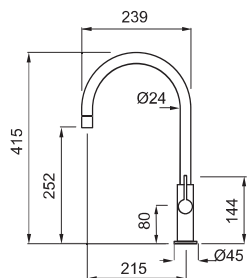

CR Hromēts

### APDARE Cena € 196,-

|            |           |
|------------|-----------|
| Hromēts CR | MIKVTA CR |
|------------|-----------|

### KRĀSA \* Cena € 221,-

|               |          |
|---------------|----------|
| Black K86     | MKKVTA86 |
| White K96     | MKKVTA96 |
| Titanium M73  | MMKVTA73 |
| Aluminium M79 | MMKVTA79 |
| Nero G40      | MGKVTA40 |
| Tortora G43   | MGKVTA43 |
| Cemento G48   | MGKVTA48 |
| Bianco G68    | MGKVTA68 |

## CLOUD



Vienas sviras ūdens maisītājs ar grozāmu snipi

### ĪPAŠĪBAS

|                       |                           |
|-----------------------|---------------------------|
| Pamatne (mm)          | 48                        |
| Griešanās leņķis      | 360°                      |
| Lokanās caurules      | Nerūsējošais tērauds 3/8" |
| Caurules garums       | 390 mm                    |
| Kārtridžs (ø mm)      | 35                        |
| Caurums montāžai (mm) | 35                        |

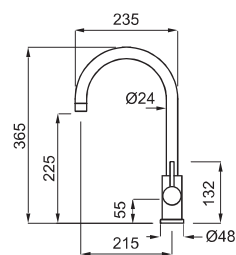

CR Hromēts

### APDARE Cena € 172,-

|            |           |
|------------|-----------|
| Hromēts CR | MIKCLO CR |
|------------|-----------|

### KRĀSA \* Cena € 208,-

|                   |          |
|-------------------|----------|
| Black K86         | MKKCLO86 |
| Dove Grey K93     | MKKCLO93 |
| Champagne K95     | MKKCLO95 |
| White K96         | MKKCLO96 |
| Light Grey K97    | MKKCLO97 |
| Dark Grey K99     | MKKCLO99 |
| Nero Metal M70    | MMKCLO70 |
| Titanium M73      | MMKCLO73 |
| Aluminium M79     | MMKCLO79 |
| Nero G40          | MGKCLO40 |
| Tortora G43       | MGKCLO43 |
| Cemento G48       | MGKCLO48 |
| Bianco G68        | MGKCLO68 |
| Espresso G78      | MGKCLO78 |
| Avena G51         | MGKCLO51 |
| Antracite G59     | MGKCLO59 |
| Bianco Antico G62 | MGKCLO62 |

\* Krāsas, kas atbilst Keratek un Granitek materiāliem

## CADDY



Vienas sviras ūdens maisītājs ar grozāmu snipi

### ĪPAŠĪBAS

Pamatne (mm) **50**  
Griešanās leņķis **360°**  
Lokanās caurules

**Nerūsējošais tērauds 3/8"**  
Caurules garums **350 mm**  
Kārtridžs (ø mm) **35**  
Caurums montāžai (mm) **35**

### APDARE Cena € 82,-

**Hromēts** MIKC01CR  
CR

### KRĀSA \* Cena € 88,-

**Nero** MGKC0140  
G40  
 **Tortora** MGKC0143  
G43  
 **Cemento** MGKC0148  
G48  
 **Bianco** MGKC0168  
G68  
 **Avena** MGKC0151  
G51

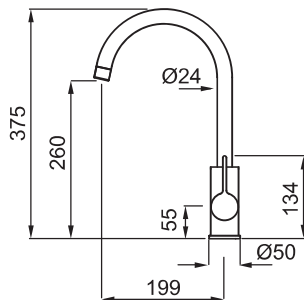

## SHELL PLUS



Vienas sviras ūdens maisītājs ar grozāmu snipi un izvelkamu uzgali

### ĪPAŠĪBAS

Pamatne (mm) **50**  
Griešanās leņķis **360°**  
Lokanās caurules **Nerūsējošais tērauds 3/8"**  
Caurules garums **350 mm**  
Kārtridžs (ø mm) **35**  
Caurums montāžai (mm) **35**

### APDARE Cena € 118,-

**Hromēts** MIKC02CR  
CR

### KRĀSA \* Cena € 125,-

**Nero** MGKC0240  
G40  
 **Tortora** MGKC0243  
G43  
 **Cemento** MGKC0248  
G48  
 **Bianco** MGKC0268  
G68  
 **Avena** MGKC0251  
G51

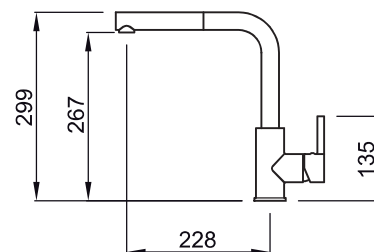

ŪDENS MAISĪTĀJI

\* Krāsas, kas atbilst Keratek un Granitek materiāliem

## ŪDENS MAISĪTĀJI SHELL



Vienas sviras ūdens maisītājs ar grozāmu snipi



### ĪPAŠĪBAS

|                       |                                  |
|-----------------------|----------------------------------|
| Pamatne (mm)          | <b>50</b>                        |
| Griešanās leņķis      | <b>360°</b>                      |
| Lokanās caurules      | <b>Nerūsējošais tērauds 3/8"</b> |
| Caurules garums       | <b>350 mm</b>                    |
| Kārtridžs (ø mm)      | <b>35</b>                        |
| Caurums montāžai (mm) | <b>35</b>                        |

### APDARE Cena € 92,-

|  |          |
|--|----------|
|  <b>Hromēts</b><br>CR | MIKS01CR |
|--|----------|

### KRĀSA \* Cena € 101,-

|  |          |
|--|----------|
|  <b>Nero</b><br>G40   | MGKS0140 |
|  <b>Bianco</b><br>G68 | MGKS0168 |
|  <b>Avena</b><br>G51  | MGKS0151 |

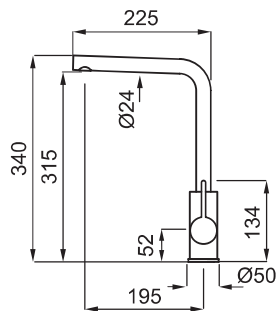

## IXORA



Vienas sviras ūdens maisītājs ar grozāmu snipi



### ĪPAŠĪBAS

|                       |                                  |
|-----------------------|----------------------------------|
| Pamatne (mm)          | <b>45</b>                        |
| Griešanās leņķis      | <b>360°</b>                      |
| Lokanās caurules      | <b>Nerūsējošais tērauds 3/8"</b> |
| Caurules garums       | <b>350 mm</b>                    |
| Kārtridžs (ø mm)      | <b>25</b>                        |
| Caurums montāžai (mm) | <b>35</b>                        |

### APDARE Cena € 182,-

|   |          |
|---|----------|
|  <b>Nerūsējošais tērauds</b><br>IN | MIKX01IN |
|---|----------|

### KRĀSA \* Cena € 169,-

|   |          |
|---|----------|
|  <b>Black</b><br>K86 | MKKX0186 |
|  <b>Nero</b><br>G40  | MGKX0140 |

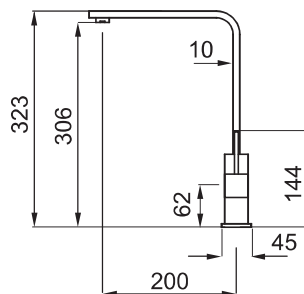

\* Krāsas, kas atbilst Keratek un Granitek materiāliem

## ŪDENS MAISĪTĀJI DRIVE



Vienas sviras ūdens maisītājs ar grozāmu snipi

### ĪPAŠĪBAS

|                       |                           |
|-----------------------|---------------------------|
| Pamatne (mm)          | 50                        |
| Griešanās leņķis      | 360°                      |
| Lokanās caurules      | Nerūsējošais tērauds 3/8" |
| Caurules garums       | 35 mm                     |
| Kārtridzs (ø mm)      | 25                        |
| Caurums montāžai (mm) | 35                        |



### APDARE Cena € 91,-

|  |          |
|--|----------|
|  Hromēts CR | MIKD01CR |
|--|----------|

### APDARE Cena € 132,-

|   |          |
|---|----------|
|  Nerūsējošais tērauds IN | MIKD01IN |
|---|----------|

### KRĀSA \* Cena € 118,-

|  |          |
|--|----------|
|  Black BK | MKKD0186 |
|  Nero G40 | MGKD0140 |

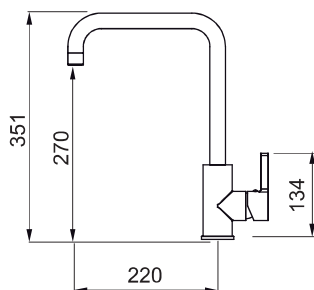

## ellect | VIRTUVE

## ALUNA PLUS



Vienas sviras ūdens maisītājs ar grozāmu snipi un izvelkamu uzgali

### ĪPAŠĪBAS

|                       |                           |
|-----------------------|---------------------------|
| Pamatne (mm)          | 50                        |
| Griešanās leņķis      | 360°                      |
| Lokanās caurules      | Nerūsējošais tērauds 3/8" |
| Caurules garums       | 40 mm                     |
| Kārtridzs (ø mm)      | 35                        |
| Caurums montāžai (mm) | 35                        |

### APDARE Cena € 169,-

|  |          |
|--|----------|
|  Hromēts CR | MIKA02CR |
|--|----------|

### APDARE Cena € 195,-

|   |          |
|---|----------|
|  Nerūsējošais tērauds IN | MIKA02IN |
|---|----------|

### KRĀSA \* Cena € 183,-

|   |          |
|---|----------|
|  Black K86 | MKKA0286 |
|  Nero G40  | MGKA0240 |

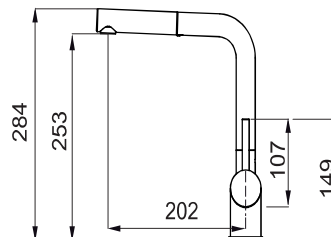

ŪDENS MAISĪTĀJI

\* Krāsas, kas atbilst Keratek un Granitek materiāliem

## ŪDENS MAISĪTĀJI SAVA



Vienas sviras ūdens maisītājs ar grozāmu snipi

### ĪPAŠĪBAS

|                       |                                  |
|-----------------------|----------------------------------|
| Pamatne (mm)          | <b>50</b>                        |
| Griešanās leņķis      | <b>360°</b>                      |
| Lokanās caurules      | <b>Nerūsējošais tērauds 3/8"</b> |
| Caurules garums       | <b>350 mm</b>                    |
| Kārtridžs (ø mm)      | <b>35</b>                        |
| Caurums montāžai (mm) | <b>35</b>                        |

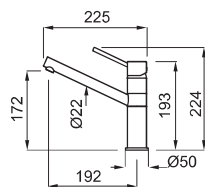

CR Hromēts

### APDARE Cena € 163,-

|  |          |
|--|----------|
|  <b>Hromēts</b><br>CR | MIKSAVCR |
|--|----------|

### KRĀSA \* Cena € 196,-

|   |          |
|---|----------|
|  <b>Black</b><br>K86         | MKKSAV86 |
|  <b>White</b><br>K96         | MKSAV96  |
|  <b>Nero Metal</b><br>M70    | MMKSAV70 |
|  <b>Titanium</b><br>M73      | MMKSAV73 |
|  <b>Aluminium</b><br>M79     | MMKSAV79 |
|  <b>Nero</b><br>G40          | MGKSAV40 |
|  <b>Tortora</b><br>G43       | MGKSAV43 |
|  <b>Cemento</b><br>G48       | MGKSAV48 |
|  <b>Bianco</b><br>G68        | MGKSAV68 |
|  <b>Espresso</b><br>G78      | MGKSAV78 |
|  <b>Avena</b><br>G51         | MGKSAV51 |
|  <b>Antracite</b><br>G59     | MGKSAV59 |
|  <b>Bianco Antico</b><br>G62 | MGKSAV62 |

## RENO

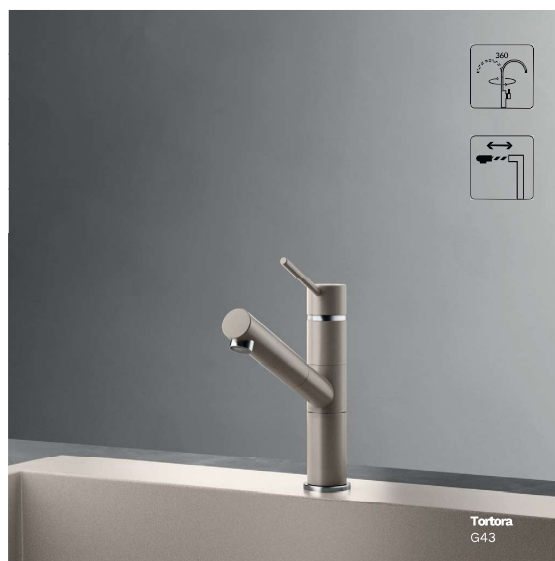

Vienas sviras ūdens maisītājs ar grozāmu snipi un izvelkamu uzgali

### ĪPAŠĪBAS

|                       |                                  |
|-----------------------|----------------------------------|
| Pamatne (mm)          | <b>50</b>                        |
| Griešanās leņķis      | <b>360°</b>                      |
| Lokanās caurules      | <b>Nerūsējošais tērauds 3/8"</b> |
| Caurules garums       | <b>350 mm</b>                    |
| Kārtridžs (ø mm)      | <b>35</b>                        |
| Caurums montāžai (mm) | <b>35</b>                        |

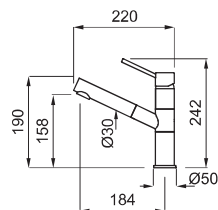



CR Hromēts

### APDARE Cena € 221,-

|  |          |
|--|----------|
|  <b>Hromēts</b><br>CR | MIKRENCR |
|--|----------|

### KRĀSA \* Cena € 245,-

|   |          |
|---|----------|
|  <b>Black</b><br>K86         | MKKREN86 |
|  <b>White</b><br>K96         | MKKREN96 |
|  <b>Nero Metal</b><br>M70    | MMKREN70 |
|  <b>Titanium</b><br>M73      | MMKREN73 |
|  <b>Aluminium</b><br>M79     | MMKREN79 |
|  <b>Nero</b><br>G40          | MGKREN40 |
|  <b>Tortora</b><br>G43       | MGKREN43 |
|  <b>Cemento</b><br>G48       | MGKREN48 |
|  <b>Bianco</b><br>G68        | MGKREN68 |
|  <b>Espresso</b><br>G78      | MGKREN78 |
|  <b>Avena</b><br>G51         | MGKREN51 |
|  <b>Antracite</b><br>G59     | MGKREN59 |
|  <b>Bianco Antico</b><br>G62 | MGKREN62 |

\* Krāsas, kas atbilst Keratek un Granitek materiāliem

## SENNA



Vienas sviras ūdens maisītājs ar grozāmu snipi



### ĪPAŠĪBAS

|                       |                           |
|-----------------------|---------------------------|
| Pamatne (mm)          | 54                        |
| Griešanās leņķis      | 360°                      |
| Lokanās caurules      | Nerūsējošais tērauds 3/8" |
| Caurules garums       | 350 mm                    |
| Kārtridzs (ø mm)      | 35                        |
| Caurums montāžai (mm) | 35                        |

### APDARE Cena € 135,-

|  |          |
|--|----------|
|  Hromēts CR | MIKSENCR |
|--|----------|

### KRĀSA \* Cena € 172,-

|   |          |
|---|----------|
|  Nero G40          | MGKSEN40 |
|  Bianco G68        | MGKSEN68 |
|  Avena G51         | MGKSEN51 |
|  Antracite G59     | MGKSEN59 |
|  Bianco Antico G62 | MGKSEN62 |

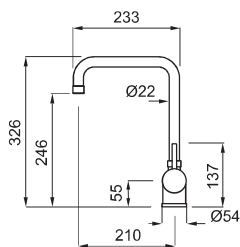

CR Hromēts

## PO



Vienas sviras ūdens maisītājs ar grozāmu snipi

### ĪPAŠĪBAS

|                       |                           |
|-----------------------|---------------------------|
| Pamatne (mm)          | 51                        |
| Griešanās leņķis      | 360°                      |
| Lokanās caurules      | Nerūsējošais tērauds 3/8" |
| Caurules garums       | 330 mm                    |
| Kārtridzs (ø mm)      | 35                        |
| Caurums montāžai (mm) | 35                        |

### APDARE Cena € 159,-

|  |         |
|--|---------|
|  Hromēts CR | MIKPOCR |
|--|---------|

### KRĀSA \* Cena € 196,-

|   |         |
|---|---------|
|  Titanium M73      | MMKPO73 |
|  Aluminium M79     | MMKPO79 |
|  Nero G40          | MGKPO40 |
|  Bianco G68        | MGKPO68 |
|  Avena G51         | MGKPO51 |
|  Antracite G59     | MGKPO59 |
|  Bianco Antico G62 | MGKPO62 |

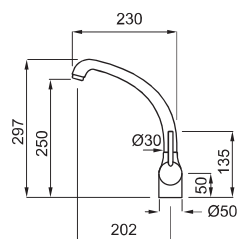

CR Hromēts

ŪDENS MAISĪTĀJI

\*Krāsas, kas atbilst Keratek un Granitek materiāliem

## ŪDENS MAISĪTĀJI MINERVA



Vienas sviras ūdens maisītājs ar grozāmu snipi

### ĪPAŠĪBAS

|                       |                                  |
|-----------------------|----------------------------------|
| Pamatne (mm)          | <b>50</b>                        |
| Griešanās leņķis      | <b>360°</b>                      |
| Lokanās caurules      | <b>Nerūsējošais tērauds 3/8"</b> |
| Caurules garums       | <b>350 mm</b>                    |
| Kārtridzs (ø mm)      | <b>35</b>                        |
| Caurums montāžai (mm) | <b>35</b>                        |

### APDARE Cena € 98,-

|  |          |
|--|----------|
|  <b>Hromēts</b><br>CR | MIKMINCR |
|--|----------|

### KRĀSA \* Cena € 123,-

|   |          |
|---|----------|
|  <b>Titanium</b><br>M73      | MMKMIN73 |
|  <b>Aluminium</b><br>M79     | MMKMIN79 |
|  <b>Nero</b><br>G40          | MGKMIN40 |
|  <b>Bianco</b><br>G68        | MGKMIN68 |
|  <b>Avena</b><br>G51         | MGKMIN51 |
|  <b>Antracite</b><br>G59     | MGKMIN59 |
|  <b>Bianco Antico</b><br>G62 | MGKMIN62 |

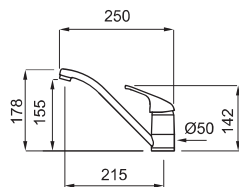

CR Hromēts

## VENERE

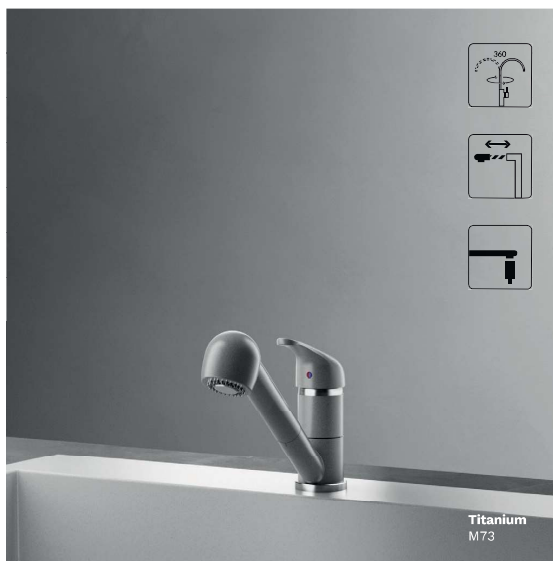

Vienas sviras ūdens maisītājs ar grozāmu snipi un izvelkamu uzgali

### ĪPAŠĪBAS

|                       |                                  |
|-----------------------|----------------------------------|
| Pamatne (mm)          | <b>50</b>                        |
| Griešanās leņķis      | <b>360°</b>                      |
| Lokanās caurules      | <b>Nerūsējošais tērauds 3/8"</b> |
| Caurules garums       | <b>350 mm</b>                    |
| Kārtridzs (ø mm)      | <b>35</b>                        |
| Caurums montāžai (mm) | <b>35</b>                        |

### APDARE Cena € 122,-

|  |          |
|--|----------|
|  <b>Hromēts</b><br>CR | MIKVENCR |
|--|----------|

### KRĀSA \* Cena € 147,-

|   |          |
|---|----------|
|  <b>Titanium</b><br>M73      | MMKVEN73 |
|  <b>Aluminium</b><br>M79     | MMKVEN79 |
|  <b>Bianco</b><br>G68        | MGKVEN68 |
|  <b>Avena</b><br>G51         | MGKVEN51 |
|  <b>Antracite</b><br>G59     | MGKVEN59 |
|  <b>Bianco Antico</b><br>G62 | MGKVEN62 |

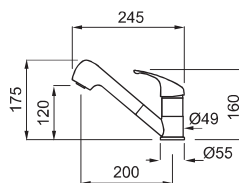

CR Hromēts

\* Krāsas, kas atbilst Keratek un Granitek materiāliem



# RIO



Vienas sviras ūdens maisītājs ar grozāmu snipi

## ĪPAŠĪBAS

Pamatne (mm) **54**  
 Griešanās leņķis **360°**  
 Lokanās caurules

Caurules garums **350 mm**  
 Kārtridžs (ø mm) **35**  
 Caurums montāžai (mm) **35**

## APDARE Cena € 172,-

 **Hromēts** MIKRIOCR  
 CR

## APDARE Cena € 208,-

 **Vara krāsa** MIKRIORA  
 RA

## KRĀSA \* Cena € 208,-

 **Avena** MGKRIO51  
 G51

 **Antracīte** MGKRIO59  
 G59

 **Bianco Antico** MGKRIO62  
 G62

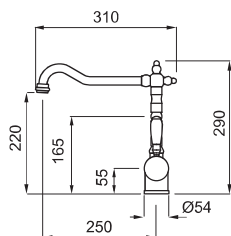

CR Hromēts

\* Krāsas, kas atbilst Keratek un Granitek materiāliem



ŪDENS MAISĪTĀJI

KOLEKCIJA

# PĀRTIKAS ATKRITUMU SMALCINĀTĀJI

2 ANNI-YEARS  
WARRANTY  
GARANTITO

Atkritumu smalcinātāji ir būtiska mūsdienīga iekārta, kas likvidē organiskos atkritumus un atvieglo dzīvi virtuvē.

Ar vienkāršu pogas nospiešanu, pārtika tiek samalta un izvadīta kanalizācijā.

Viegli uzstādāms, kompakts, kluss un drošs.

Pārtikas atkritumi tiek samalti sīkās daļiņās un kopā ar notekūdeņiem tiek novadīti kanalizācijas sistēmā.

#### PRIEKŠROCĪBAS

Nav nepatīkamas smakas  
Energijas taupīšana  
Pārstrādājamo atkritumu samazināšana  
Veselīgāka vide  
CO<sub>2</sub> samazināšana

#### PAR 40% KLUSĀKS

Visas Elleci atkritumu smalcināšanas iekārtas ir izstrādātas tā, lai maksimāli samazinātu vibrācijas koeficientu un trokšņa koeficientu. Šo divu faktoru dēļ Elleci atkritumu smalcināšanas iekārtas ir par 40% klusākas nekā tradicionālie līdzīgie izstrādājumi.

#### LIELA SMALCINĀŠANAS KAMERA

Lielāks kameras tilpums nozīmē mazāku iesprūšanas risku un labāku smalcināšanu.

ŠĪ IEKĀRTA ĻAUJ ATBRĪVOTIES NO ORGANISKAJIEM ATKRITUMIEM, PIEMĒRAM, AUGĻIEM, DĀRZENIEM, ZIVJU ASAKĀM, OLU ČAUMALĀM, VISTAS KAULIEM UN DAUDZ CĪTU

Nav ieteicams izmest šķiedrvielu saturošus pārtikas produktus, piemēram, artišokus, fenheli, ananāsus utt.

## AUGSTAS KVALITĀTES NERŪSĒJOŠĀ TĒRAUDA DETAĻAS



- 1 Ātra un vienkārša uzstādīšana
- 2 Antibakteriālā aizsardzība un smaku novēršanas sistēma
- 3 Nerūsējošā tērauda sastāvdaļas
- 4 Lieljaudas DC motor
- 5 Inovatīvs itāļu dizains
- 6 Drošības slēdzis
- 7 Pneimo poga

## 1000 BLACK

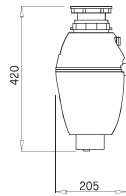

4.8  
KG

### ĪPAŠĪBAS **Cena € 400,-**

Izmērs (mm)  
205 X 420  
Deluxe 1 Hp  
Art.TDH01000BK

Jauda vatos : 750  
Strāvas spriegums : 220/240  
Ienākošie ampēri : 3.4  
Apgriezieni r/min.: 2800  
Svars 4.8  
Tilpums : 1070 ml.

### IEKĻAUTS KOMPLEKTĀ



NOPLŪDES  
LENĶIS



GUMIJAS AIZSARGS PRET  
ŠLAKATĀM, IZNEMAMS UN  
MAZGĀJAMS TRĀUKU MAŠĪNĀ



STAMPĪNA



STANDARTA  
AIZBĀZNIS



PNEIMATISKĀ  
IESLĒGŠANAS POGA  
(BEZ ELEKTRĪBAS)

### IETEICAMIE PIEDERUMI



SAVIENOJUMS  
KANTAINIEM IZVADIEM  
Lpp.143



TĀLVADĪBAS  
PULTS  
Lpp.143

## 1000 TOP

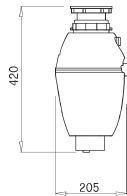

4.8  
KG

### ĪPAŠĪBAS **Cena € 350,-**

Izmērs (mm)  
205 X 420  
Deluxe 1 Hp  
Art.TDH01000

Jauda vatos : 750  
Strāvas spriegums : 220/240  
Ienākošie ampēri : 3.4  
Apgriezieni r/min.: 2800  
Svars 4.8  
Tilpums : 1070 ml.

## 750 TOP

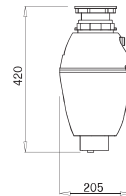

4.7  
KG

### ĪPAŠĪBAS **Cena € 306,-**

Izmērs (mm)  
205 X 420  
3/4 HP  
Art.TDH00750

Jauda vatos : 550  
Voltage in VAC: 220/240  
Ienākošie ampēri : 2.5  
Apgriezieni r/min.: 2800  
Svars 4.7  
Tilpums : 1070 ml.

## 750

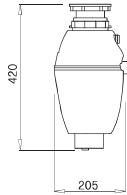

4.5  
KG

### ĪPAŠĪBAS **Cena € 275,-**

Izmērs (mm)  
205 X 420  
3/4 HP  
Art.TDM07500

Jauda vatos : 550  
Strāvas spriegums : 220/240  
Ienākošie ampēri : 2.5  
Apgriezieni r/min.: 2800  
Svars 4.5  
Tilpums : 860 ml.

## 500 TOP

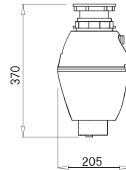

4.5  
KG

### ĪPAŠĪBAS **Cena € 246,-**

Izmērs (mm)  
205 X 370  
1/2 HP  
Art.TDH00500

Jauda vatos: 375  
Strāvas spriegums 220/240  
Ienākošie ampēri : 1.7  
Apgriezieni r/min.: 2800  
Svars 4.5  
Tilpums : 1070 ml.



Produktu linija ar īpašībām, kas īpaši izstrādāta, lai atvieglotu ikdienas tīrīšanu un virsmu kopšanu tieši Elleci produktiem.

elleci | BEAUTY



PAPILDUS  
INFORMĀCIJA



DLL01602 **Cena € 16,-**

0.2 LT/KG

**DAILY CLEANER- ATTAUKOŠANA**

Attaukojošs izsmidzināms tīrīšanas līdzeklis noņem netīrumu, mikrobu un baktēriju pēdas, nesabojājot virsmas. Produkts paredzēts regulārai ELLECI izlietņu kopšanai.



DLC01603 **Cena € 21,-**

0.2 LT/KG

**DEEP CLEANER – EXTRA ACTION**

Krēmveida mazgāšanas līdzeklis traipu noņemšanas efektu, noņem noturīgus traipus no visām ELLECI gaišās krāsas akmeņ masas izlietnēm.



DLA01603 **Cena € 16,-**

0.2 LT/KG

**DAILY CLEANER- ATKAĻĶOTĀJS**

Atkalķošanas aerosols, izšķīdina kaļķakmens uzkrāšanos un vienlaikus aizsargā virsmu. Produkts paredzēts regulārai ELLECI izlietņu tīrīšanai.



DLP01601 **Cena € 17,-**

0.1 LT/KG

**BEAUTY PROTECTOR**

Aizsargājošs tīrīšanas aerosols, noturīgs pret netīrumiem un kaļķakmens paliekām, kā arī laika gaitā saglabā produkta skaistumu atsvaidzinot krāsu un uzlabo ūdens atgrūdošās īpašības.



**EKSPOZĪCIJAS DISPLEJS  
KOPŠANAS LĪDZEKĻIEM**

Ērta saliekama kartona kaste, kas pieejama pēc pieprasījuma.



DLA01602 **Cena € 17,-**

0.25 LT/KG

**DAILY CLEANER – CLEAN POWER**

Īpašs izsmidzināms tīrīšanas līdzeklis krāsainām un emaljētām virsmām. Paredzēts ELLECI krāsaino jaucējkrānu un citu virtuves ierīču ikdienas tīrīšanai.



DKP01000 **Cena € 12,-**

**FAST CLEAN – SŪKĻU KOMPLEKTS**

Komplekts, kas sastāv no trim izturīgiem sūkļiem ar dubultu slāni, lai noņemtu pat visnoturīgākos netīrumus. Baltā daļa darbojas, nesaskrāpējot smalkas virsmas, savukārt zilā daļa ir mikstāka un tai piemīt absorbācijas spēja.



DKP01001 **Cena € 13,-**

**FAST CLEAN – MIKROŠĶIEDRAS DRĀNA**

Komplekts, kas sastāv no divām mikrošķiedras drānām ar īpašu ļoti labi absorbējošu efektu, lai izlietne būtu sausa un tīra nesabojājot virsmu.

# KOPŠANA UN UZTURĒŠANA



Uzturēt Elleci produkta skaistumu un funkcionalitāti laika gaitā ir ārkārtīgi vienkārši. Viss, kas jums jā dara, ir katru dienu jātīra un jāizžāvē produkts, izmantojot neitrālus mazgāšanas līdzekļus vai ar konkrētiem Elleci Beauty līnijas produktiem, neļaujot nosēdumiem un atlikumiem ilgstoši iedarboties uz virsmām.



PAPILDUS  
BRĪDINĀJUMI  
UN PADOMI



Notīriet visus trāpus, izmantojot mikstu sūkli un neitrālu trauku mazgāšanas līdzekli vai konkrētu Elleci Beauty līnijas produktu.



Rūpīgi noskalojiet virsmas, izmantojot remdenu ūdeni.













Uzmanīgi nosusiniet virsmu, izmantojot mikstu drānu vai mikrošķiedras drānu, lai novērstu kaļķakmens nosēdumu veidošanos.











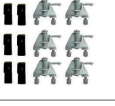





Lai novērstu kaļķakmens traipu veidošanos uz virsmas, iesakām veikt rūpīgāku tīrīšanu vienu vai divas reizes nedēļā izmantojot atkaļķošanas tīrīšanas līdzekli, piemēram, Daily Clean atkaļķošanas aerosolu no Elleci Beauty līnijas.

## REZERVES DAĻAS

|   |   |  |
|---|---|--|
|    | <b>NERŪSĒJOŠĀ TĒRAUDA FLOW-PRO NOPLŪDES KOMPLEKTS</b><br>3.5" VENTILU FLOW-PRO KOMPLEKTS AR SIETIŅGROZU UN<br>GOFRĒTU CAURULI PĀRPLŪDES PIEVIENOŠANAI, PĀRPLŪDE<br>NAV IEKĻAUTA                                       | <b>Cena € 31,-</b><br>WPT90CTPLUXF       |
|    | <b>TAISNSTŪRA PĀRPLŪDES KOMPLEKTS</b><br>TAISNSTŪRA PĀRPLŪDE UN NERŪSRĒJOŠĀ TĒRAUDA PLĀKSNĪTE<br>KOMPLEKTĀ AR SAVIENOJUMIEM   | <b>Cena € 9,-</b><br>KTSMELL             |
|    | <b>MELNS FLOW-PRO NOPLŪDES KOMPLEKTS AR TAISNSTŪRA PARPLŪDI</b><br>3.5" VENTILU FLOW-PRO KOMPLEKTS AR MELNU SIETIŅGROZU,<br>GOFRĒTU CAURULI PĀRPLŪDES PIEVIENOŠANAI UN MELNA<br>TAISNSTŪRA PĀRPLŪDE                   | <b>Cena € 96,-</b><br>KITWPT-F-1VSELL-BK |
|    | <b>ZELTA KRĀSĀ FLOW-PRO NOPLŪDES KOMPLEKTS AR TAISNSTŪRA PARPLŪDI</b><br>3.5" VENTILU FLOW-PRO KOMPLEKTS AR SIETIŅGROZU ZELTA KRĀSĀ,<br>GOFRĒTU CAURULI PĀRPLŪDES PIEVIENOŠANAI UN TAISNSTŪRA PĀRPLŪDI<br>ZELTA KRĀSĀ | <b>Cena € 79,-</b><br>KITWPT-F-1VSELL-GD |
|    | <b>FLOW-PRO SIETIŅGROZS</b><br>FLOW-PRO SIETIŅGROZS, MATĒTS NERŪSĒJOŠAIS TĒRAUDS  | <b>Cena € 21,-</b><br>TAPP01IN           |
|    | <b>FLOW-PRO SIETIŅGROZS</b><br>FLOW-PRO SIETIŅGROZS, MELNS  | <b>Cena € 79,-</b><br>TAPP01BK           |
|    | <b>FLOW-PRO SIETIŅGROZS</b><br>FLOW-PRO SIETIŅGROZS, ZELTA KRĀSĀ  | <b>Cena € 58,-</b><br>TAPP01GD           |
|   | <b>NERŪSĒJOŠĀ TĒRAUDA FLOW NOPLŪDES KOMPLEKTS</b><br>3.5" VENTILU FLOW KOMPLEKTS AR SIETIŅGROZU UN<br>GOFRĒTU CAURULI PĀRPLŪDES PIEVIENOŠANAI, PĀRPLŪDE<br>NAV IEKĻAUTA   | <b>Cena € 31,-</b><br>WPT90CTPLUXFB      |
|  | <b>NERŪSĒJOŠĀ TĒRAUDA NOPLŪDES KOMPLEKTS</b><br>3.5" VENTILU KOMPLEKTS AR SIETIŅGROZU UN GOFRĒTU<br>CAURULI PĀRPLŪDES PIEVIENOŠANAI, PĀRPLŪDE NAV IEKĻAUTA  | <b>Cena € 9,-</b><br>WBB90CTPLUXR        |
|  | <b>NERŪSĒJOŠĀ TĒRAUDA NOPLŪDES KOMPLEKTS</b><br>3.5" VENTILU KOMPLEKTS AR SIETIŅGROZU   | <b>Cena € 9,-</b><br>WBB90STPLUXR        |
|  | <b>NERŪSĒJOŠĀ TĒRAUDA NOPLŪDES KOMPLEKTS - KANTAINS</b><br>KANTAINS 3.5" VENTILU KOMPLEKTS AR SIETIŅGROZU UN GOFRĒTU<br>CAURULI PĀRPLŪDES PIEVIENOŠANAI, PĀRPLŪDE NAV IEKĻAUTA  | <b>Cena € 35,-</b><br>WPT90CTPLUXQ       |
|  | <b>NOPLŪDES KOMPLEKTS</b><br>70 MM VENTILU KOMPLEKTS AR SIETIŅGROZU<br>KOMPLEKTS TIKAI EASY 325 UN EASY 425 IZLIETNĒM   | <b>Cena € 11,-</b><br>WPT70STPLUXA       |
|  | <b>PĀRPLŪDES KOMPLEKTS</b><br>PĀRPLŪDES KOMPLEKTS AR APAĻU NERŪSĒJOŠĀ TĒRAUDA<br>PIEVIENOŠANAS PLĀKSNĪTI  | <b>Cena € 7,-</b><br>KTTMELL             |
|  | <b>SIFONA KOMPLEKTS</b><br>UNIVERSĀLS, VIETU EKONOMĒJOŠS SIFONS   | <b>Cena € 7,-</b><br>COMPSIF1V           |
|  | <b>VENTILU SAVIENOJUMS</b><br>VENTILU SAVIENOJUMS DIVĀM BĻODĀM VIENĀ LĪMENĪ AR<br>UNIVERSĀLU, VIETU EKONOMĒJOŠU SIFONU  | <b>Cena € 9,-</b><br>COMPSIF2V           |
|  | <b>VENTILU SAVIENOJUMS</b><br>VENTILU SAVIENOJUMS DIVĀM BĻODĀM DAŽĀDOS LĪMEŅOS AR<br>UNIVERSĀLU, VIETU EKONOMĒJOŠU SIFONU   | <b>Cena € 9,-</b><br>COMPSIF2VU          |

AKMENS MASAS IZLIETNES

|   |   |                               |                                 |
|---|---|-------------------------------|---------------------------------|
|    | <b>MONTĀŽAS ĀĶI IEGRIEŽAMĀM IZLIETNĒM</b><br>6 GAB. 23° MONTĀŽAS ĀĶI KOMPLEKTĀ AR SKRŪVĒM UN BĪBEĻIEM, AKMENS MASAS IZLIETŅU UZSTĀDĪŠANAI                                     | Cena € 10,-<br>BOXGAN06       | AKMENS MASAS IZLIETNES          |
|    | <b>MONTĀŽAS ĀĶI IEGRIEŽAMĀM IZLIETNĒM</b><br>6 GAB. 90° MONTĀŽAS ĀĶI KOMPLEKTĀ AR SKRŪVĒM UN BĪBEĻIEM, AKMENS MASAS IZLIETŅU UZSTĀDĪŠANAI                                     | Cena € 10,-<br>BOXGAN06S      |                                 |
|    | <b>MONTĀŽAS ĀĶI MONTĀŽAI NO APAKŠAS</b><br>6 GAB. MONTĀŽAS ĀĶI IZLIETNES MONTĀŽAI NO APAKŠAS  | Cena € 15,-<br>AKS01301       |                                 |
|    | <b>URBIS</b><br>URBIS 35 MM, CAURUMU URBŠANAI JAUCĒJKRĀNIEM AKMENS MASAS IZLIETNĒS  | Cena € 15,-<br>FRES17         |                                 |
|    | <b>KOPŠANAS LĪDZEKĻU STENDS</b><br>KARTONA KOPŠANAS LĪDZEKĻU EKSPOZĪCIJAS STENDS  | PĒC PIEPRASĪJUMA              |                                 |
|    | <b>KANTAINS NOPLŪDES KOMPLEKTS AR TAISNSTŪRA PARPLŪDI</b><br>KANTAINS 3.5" VENTĪĻU KOMPLEKTS AR SIETĪNGROZU UN GOFRĒTU CAURULI PĀRPLŪDES PIEVIENOŠANAI UN TAISNSTŪRA PĀRPLŪDE | Cena € 35,-<br>COMPP90CTPLUXW | TĒRAUDA IZLIETNES               |
|    | <b>NOPLŪDES KOMPLEKTS AR TAISNSTŪRA PARPLŪDI</b><br>3.5" VENTĪĻU KOMPLEKTS AR SIETĪNGROZU UN GOFRĒTU CAURULI PĀRPLŪDES PIEVIENOŠANAI UN TAISNSTŪRA PĀRPLŪDE                   | Cena € 10,-<br>COMPP90CTPLUXC |                                 |
|   | <b>AIZBĀZNIS</b><br>APAĻŠ AIZBĀZNIS SMALCINĀTĀJAM   | Cena € 13,-<br>IKT90004       | PĀRTIKAS ATKRITUMU SMALCINĀTĀJS |
|  | <b>STIPRINĀJUMA KOMPLEKTS</b><br>MONTĀŽAS KOMPLEKTS SMALCINĀTĀJAM AR BĪVĒM, GUMIJAS AIZSARDZĪBU UN STIPRINĀJUMA GREZDENU  | Cena € 18,-<br>IKT90001       |                                 |
|  | <b>STIPRINĀJUMA KOMPLEKTS KANTAINIEM IZVADIEM</b><br>MONTĀŽA IZLIETNĒM, KURĀM IR KANTAINS IZVADS  | Cena € 35,-<br>ATQ01300       |                                 |
|  | <b>STIPRINĀJUMA PAGARINĀTĀJS</b><br>MONTĀŽAS KOMPLEKTS AR PAGARINĀJUMU IZLIETNĒM AR LIELĀKU MATERIĀLA BIEZUMU (piem. KERAMISKAJĀM IZLIETNĒM)                                  | Cena € 54,-<br>MLT90007       |                                 |
|  | <b>NOPLŪDES LEŅĶIS</b><br>MONTĀŽAS LEŅĶIS NOTECEI   | Cena € 15,-<br>IKT90003       |                                 |
|  | <b>PNEIMO SLĒDZIS</b><br>PNEIMATISKAIS SLĒDZIS AR GUMIJAS CAURULĪTI ATKRITUMU SMALCINĀTĀJA VADĪBAI  | Cena € 25,-<br>IKT90002       |                                 |
|  | <b>GUMIJAS AIZSARGS</b><br>GUMIJAS AIZSARGS PRET ŠĻAKATĀM, IZNEMAMS UN MAZGĀJAMS TRAUKU MAZGĀJAMĀ MAŠĪNĀ  | Cena € 9,-<br>PPT90010        |                                 |
|  | <b>TĀLVADĪBAS PULTS</b><br>PULTS ATKRITUMU SMALCINĀTĀJA VADĪBAI   | Cena € 69,-<br>ARP01300       |                                 |
|  | <b>STAMPIŅA</b><br>PLASTIKĀTA STAMPIŅA ATKRITUMIEM  | Cena € 15,-<br>PPT90000       |                                 |

