

# H2D

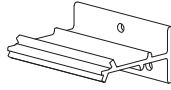

x3

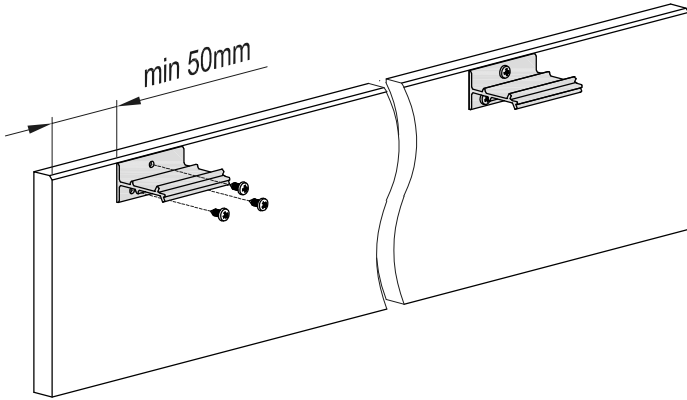

**1a**

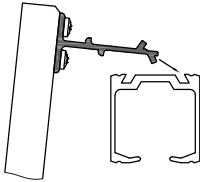

**2a**

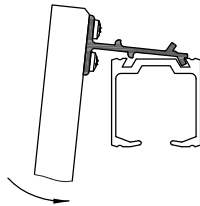

**3a**

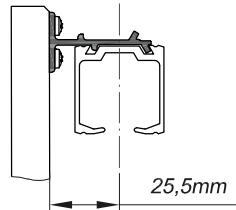

**1b**

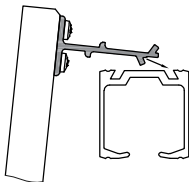

**2b**

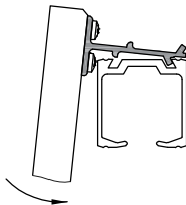

**3b**

